



# Airline

## Aluminum Structural Framing & Safeguarding Components

### FAST TRACK PROGRAM

Available for  
**QUICK SHIPMENT**  
from local inventory 



OMRON SCIENTIFIC TECHNOLOGIES, INC.



**Rexroth**  
Bosch Group



**SCHMERSAL**

Call 800-999-SERV (7378)

[www.airlinehyd.com](http://www.airlinehyd.com)



# Airline

ISO 9001:2008 Certified

## Let Airline's Engineering & Manufacturing Team transform your ideas into reality.

Bosch Rexroth Structural Framing can be configured to support a variety of applications including workstations, lean manufacturing cells, safety guards, large area enclosures, clean rooms, machine bases, solar racking and much more.

1

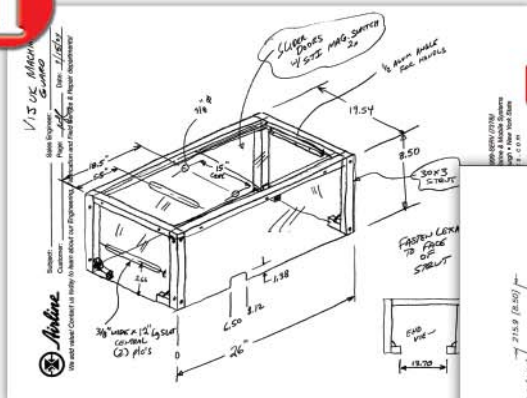

An Airline Application Engineer will consult with you at your site and develop concepts based on your needs.

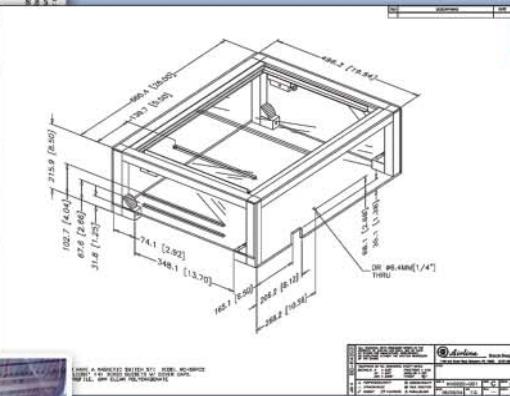

At Airline, an AutoCAD or Inventor drawing and proposal are generated for your review and approval. Once the order is placed, the design, BOM and details for production are finalized.

2



Airline's fabrication facilities offer the best in local manufacturing support.



We can supply pre-cut and pre-machined **kitted parts** ready for final assembly by your technicians

OR we can provide **completely assembled structures** for quick and easy installation.

3



If required, our field service team will deliver your designed and manufactured component to your location.













Skilled technicians can install your new component, getting you up and running in no time.

For more information, visit our website at [www.airlinehyd.com](http://www.airlinehyd.com)

1-800-999-7378

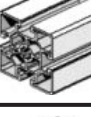

## FAST TRACK PROGRAM

### Aluminum Structural Framing

	PART NUMBER	DESCRIPTION	UNIT PRICE
	3 842 517 179	20 x 20 20-Stick Bundle	\$417.72
	3 842 517 173	20 x 20 Single 10 Ft. Stick	\$20.89
	3 842 992 888/1500	20 x 20 Cut to Length of 1,500mm*	\$13.50
	3 842 501 574	30 x 30 20-Stick Bundle	\$987.70
	3 842 502 538	30 x 30 Single 20 Ft. Stick	\$49.39
	3 842 990 720/2000	30 x 30 Cut to Length of 2,000mm*	\$19.46
	3 842 517 198	30 x 30R 20-Stick Bundle	\$1,900.37
	3 842 517 197	30 x 30R Single 18 Ft. Stick	\$95.02
	3 842 992 896/1866	30 x 30R Cut to Length of 1,866mm*	\$34.66
	3 842 512 603	30 x 60 10-Stick Bundle	\$1,267.51
	3 842 512 930	30 x 60 Single 18 Ft. Stick	\$126.75
	3 842 992 457/1866	30 x 60 Cut to Length of 1,866mm*	\$45.23
	3 842 529 339	40 x 40 20 Stick Bundle	\$1,653.36
	3 842 529 340	40 x 40 Single 20 Ft. Stick	\$82.67
	3 842 993 120/2000	40 x 40 Cut to Length of 2,000mm*	\$30.55
	8 981 004 744	45 x 45 20-Stick Bundle	\$1,653.36
	8 981 004 773	45 x 45 Single 20 Ft. Stick	\$82.67
	8 981 992 026/2000	45 x 45 Cut to Length of 2,000mm*	\$30.55
	3 842 315 100	45 x 45H 20-Stick Bundle	\$2,347.24
	3 842 507 125	45 x 45H Single 20 Ft. Stick	\$117.36
	3 842 990 520/2000	45 x 45H Cut to Length of 2,000mm*	\$42.12
	3 842 315 122	45 x 60H 20-Stick Bundle	\$3,865.28
	3 842 507 127	45 x 60H Single 20 Ft. Stick	\$193.26
	3 842 990 570/2000	45 x 60H Cut to Length of 2,000mm*	\$67.42
	3 842 511 872	60 x 60 20-Stick Bundle	\$3,714.68
	3 842 511 871	60 x 60 Single 18 Ft. Stick	\$185.73
	3 842 992 443/1866	60 x 60 Cut to Length of 1,866mm*	\$64.88
	3 842 511 782	45 x 90 12-Stick Bundle	\$2,411.67
	3 842 511 781	45 x 90 Single 18 Ft. Stick	\$200.97
	3 842 992 432/1866	45 x 90 Cut to Length of 1,866mm*	\$69.96
	3 842 315 123	45 x 90H 12-Stick Bundle	\$4,266.15
	3 842 507 123	45 x 90H Single 20 Ft. Stick	\$355.51
	3 842 990 300/2000	45 x 90H Cut to Length of 2,000mm*	\$121.50
	3 842 509 658	90 x 90 6 Stick Bundle	\$2,411.13
	3 842 509 659	90 x 90 Single 18 Ft. Stick	\$401.86
	3 842 992 415/1866	90 x 90 Cut to Length of 1,866mm*	\$136.90









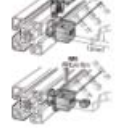

## FAST TRACK PROGRAM

### Hardware

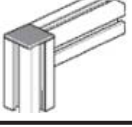
	PART NUMBER	DESCRIPTION	UNIT PRICE
	8 981 021 301	M12 x 30 Connection Screw	\$1.11
	3 842 523 970	M8 x 25 Connection Screw	\$0.42
<b>8mm T-Slot Tee Nuts:</b>			
	3 842 501 751	M-4 Thread Metric	\$0.42
	3 842 501 752	M-5 Thread Metric	\$0.42
	3 842 501 753	M-6 Thread Metric	\$0.42
	8 981 016 122	8-32 Thread English	\$0.84
	8 981 016 123	10-32 Thread English	\$0.84
	8 981 016 124	1/4-20 Thread English	\$0.56
<b>10mm T-Slot Tee Nuts:</b>			
	3 842 530 281	M-4 Thread Metric	\$0.42
	3 842 530 283	M-5 Thread Metric	\$0.42
	3 842 530 285	M-6 Thread Metric	\$0.42
	3 842 530 287	M-8 Thread Metric	\$0.42
	8 981 021 321	8-32 Thread English	\$0.84
	8 981 021 322	10-32 Thread English	\$0.84
	8 981 021 323	1/4-20 Thread English	\$0.42
	8 981 021 324	5/16-18 Thread English	\$0.56
	3 842 523 528	30 x 30 Gusset Kit with Hardware	\$3.59
	3 842 523 534	30 x 30 Round Cover Cap	\$0.67
	3 842 529 383	40 x 40 Gusset Kit with Hardware	\$5.64
	3 842 529 007	40 x 40 Round Cover Cap	\$0.95
	3 842 523 561	45 x 45 Gusset Kit with Hardware	\$3.91
	3 842 523 563	45 x 45 Round Cover Cap	\$0.63
	3 842 523 570	45 x 90 Gusset Kit with Hardware	\$6.81
	3 842 523 572	45 x 90 Round Cover Cap	\$1.46
	3 842 523 553	60 x 60 Gusset with Hardware	\$4.84
	3 842 523 555	60 x 60 Round Cover Cap	\$1.13
	3 842 523 578	90 x 90 Gusset with Hardware	\$12.01
	3 842 523 580	90 x 90 Round Cover Cap	\$2.17
	3 842 523 583	45 x 180 Gusset <u>without</u> Hardware (Foundation Bracket)	\$7.62
	3 842 523 585	45 x 180 Round Cover Cap	\$2.53
		3 842 501 962	Cover Strip, Black (8mm groove)
3 842 146 901		Cover Strip, Black (10mm groove)	\$2.39
n/a	MIS-STND152880	Polycarbonate Panel, Clear 6mm (1/4") 4' x 8'	\$202.00
n/a	MIS-MESH1X112.5GB	Wire Mesh Panel, Black, PVC Coated #12 Ga. x 1 x 1, 4' x 8'	\$50.00

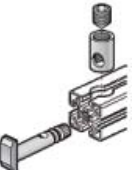
## FAST TRACK PROGRAM

### Hardware

	PART NUMBER	DESCRIPTION	UNIT PRICE
	3 842 518 351	10mm Panel Support Insert, (10mm groove, 2 meters long)	\$2.76
	3 842 519 565	Removable Panel Support Base (center mount, 8mm or 10mm groove)	\$4.04
	3 842 519 567	Removable Panel Support Glazing Strip (center mount, 8mm or 10mm groove)	\$1.60
	3 842 535 696	Variofix Panel Mounting Fasteners, without clip (8mm) [each]	\$1.14
	3 842 529 239	Variofix Panel Mounting Fasteners, without clip (10mm) [each]	\$1.29
	3 842 502 257	Leveling Foot, M8 - 30mm, Zinc	\$3.20
	3 842 352 061	Leveling Foot, M12 - 44mm, Zinc	\$7.26
	3 842 501 232	End Cap, Black (30 x 30 Strut)	\$0.73
	3 842 528 968	End Cap, Black (40 x 40 Strut)	\$1.35
	3 842 502 674	End Cap, Black (45 x 45 Strut)	\$0.68
	8 981 019 578	T-Bolt Fastening Kit, 8mm Slot, 18mm Long	\$0.67
	8 981 021 343	T-Bolt Fastening Kit, 10mm Slot, 19mm Long	\$0.63
	3 842 535 459	Quick Connect, Vertical, 8 to 8	\$5.11
	3 842 535 465	Quick Connect, Horizontal, 8 to 8	\$5.11
	3 842 535 458	Quick Connect, Vertical, 10 to 10	\$3.26
	3 842 535 466	Quick Connect, Horizontal, 10 to 10	\$3.35
	3 842 525 480	Door Handle, Small	\$2.57
	3 842 525 766	Door Handle, Large	\$4.57
	MIS-20W128O37K	Door Handle, Aluminum 35° Angle, Small	\$15.25
	MIS-26W160O37K	Door Handle, Aluminum 35° Angle, Large	\$19.74
	3 842 535 686	Heavy Duty Removable Hinge Kit (30 x 30 Strut) [each]	\$11.74
	3 842 535 692	Heavy Duty Removable Hinge Kit (45 x 45 Strut) [each]	\$11.74
	3 842 524 986	Ball Detent Latch	\$9.14

## EcoShape Tubular Framing System



### Unmatched Versatility

Rexroth's new EcoShape Tubular Framing System makes an almost unlimited number of designs possible with just 14 standard components. The only tubular framing system of its kind, it is T-slot enabled and fully compatible with profiles in Rexroth's Modular Aluminum Framing System and Manual Production Systems.



Create the perfect configuration in no time with **free MTpro planning software** available from Airline.



### EcoShape Starter Kit

Save time and money with our Starter Kit which includes:

- 50 pcs. D28L Round Tube
- 20 pcs. D28L, N10 Round Tube with T-slot
- 200 pcs. 90° Connector
- 20 pcs. 45° Connector
- 20 pcs. 0-90° Connector
- 20 pcs. Cross Connector
- 20 pcs. Parallel Connector
- 60 pcs. Threaded Sleeve D28L
- 60 pcs. End Cap Cover D28L
- 20 pcs. Adapter N10, 45
- 20 pcs. Adapter N10; 30
- 20 pcs. Leveling foot

PART NUMBER	DESCRIPTION	UNIT PRICE
3 842 555 000	EcoShape Starter Kit	\$3,150.00

# FAST TRACK PROGRAM

## EcoShape Tubular Framing Components

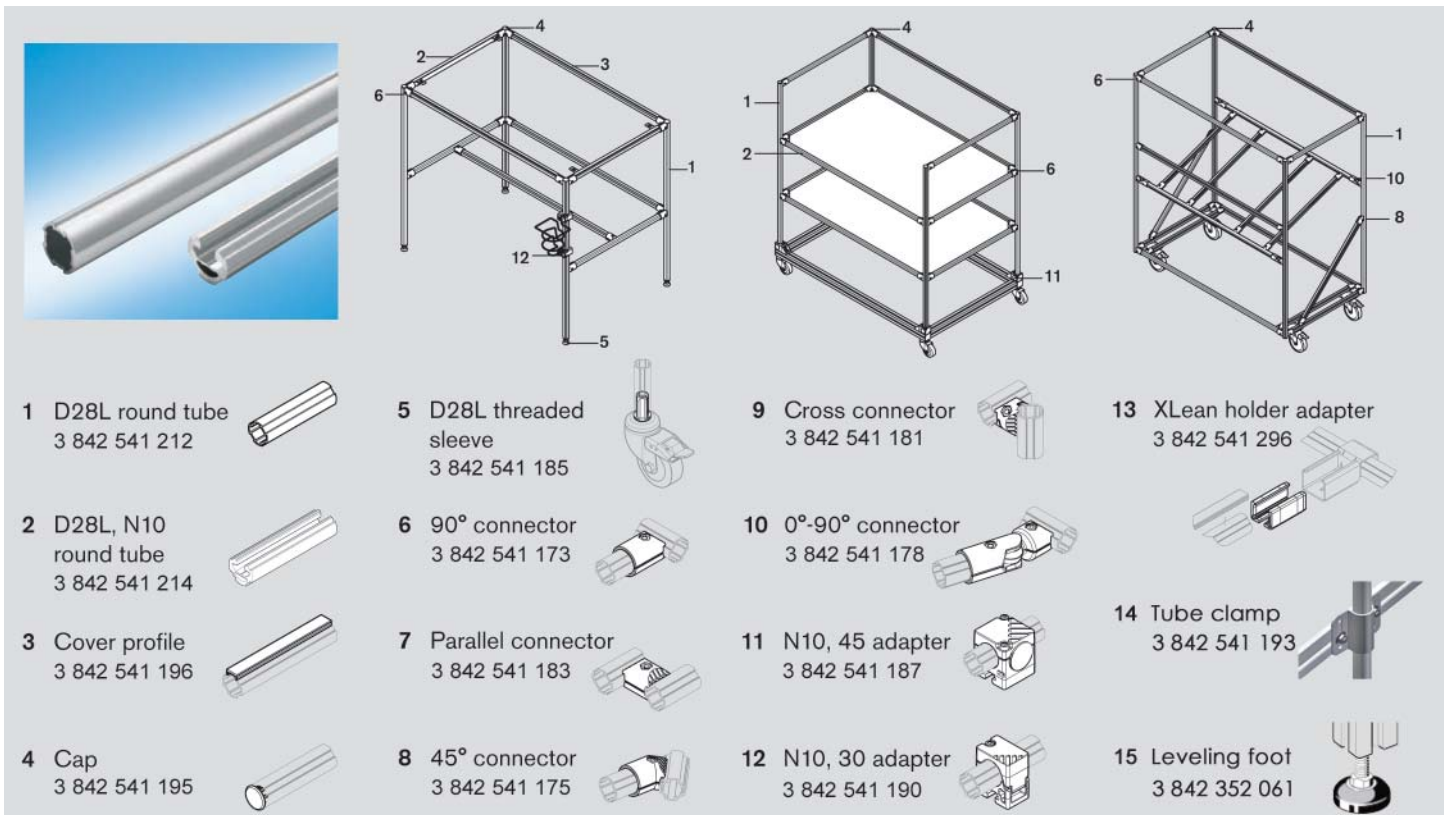

PART NUMBER	DESCRIPTION	UNIT PRICE	QTY. 100+
3 842 541 211	D28L Round Tube (above) - Bundle of 50	\$1,131.93	
3 842 541 212	D28L Round Tube D=28mm, L=5600mm (Diagram 1)	\$23.83	
3 842 996 191/_mm	D28L Round Tube Cut to Length	\$3.00 cut charge + \$0.0053 per mm	
3 842 541 213	D28L, N10 Round Tube (above) - Bundle of 20	\$691.79	
3 842 541 214	D28L, N10 Round Tube D=28mm, L=5600mm (Diagram 2)	\$36.41	
3 842 996 192/_mm	D28L, N10 Round Tube Cut to Length	\$3.00 cut charge + \$0.0079 per mm	
3 842 541 196	Slide Rail Grey L=2000 mm (Diagram 3)	\$3.96	
3 842 541 195	End Cap Cover D28L, Black ESD (Diagram 4)	\$0.88	\$0.83
3 842 541 185	Threaded Sleeve D28L (Diagram 5)	\$3.08	\$2.92
3 842 541 173	90° Connector (Diagram 6)	\$1.98	\$1.87
3 842 541 183	Parallel Connector (Diagram 7)	\$3.08	\$2.92
3 842 541 175	45° Connector (Diagram 8)	\$3.08	\$2.92
3 842 541 181	Cross Connector (Diagram 9)	\$3.08	\$2.92
3 842 541 178	0°- 90° Connector (Diagram 10)	\$5.28	\$4.95
3 842 541 187	Adapter N10, 45 (Diagram 11)	\$5.28	\$4.95
3 842 541 190	Adapter N10, 30 (Diagram 12)	\$4.18	\$3.96
3 842 541 296	XLean Holder Adapter (Diagram 13)	\$3.08	\$2.92
3 842 541 193	Tube Clamp D28L, N10 (Diagram 14)	\$3.08	\$2.92
3 842 352 061	Leveling Foot, M12 - 44mm, Zinc (Diagram 15)	\$7.26	



OMRON SCIENTIFIC TECHNOLOGIES, INC.

## SAFETY FAST TRACK PROGRAM

### Light Curtains

All light curtains on this page use SR103, G9SA or G9SP controller shown on page 9

#### MS4800 Series MiniSafe® Light Curtains

- Range: 20 m (65 ft.) dependent on minimum object resolution and protected height
- Compact size – 50 x 38 mm (2 x 1.5 in.)
- "Two-box" design - no separate control box; no cable between transmitter and receiver
- Individual Beam Indicators
- Quick and easy fixed blanking programming option "SB1"



STI MODEL #	P/N	DESCRIPTION	PRICE EA.
MS4800S-20-0440	70230-1183	Resolution: 20 mm / Protected Height: 440 mm (17.3 in.)	\$1,525.50
MS4800S-20-0600	70230-1187	Resolution: 20 mm / Protected Height: 600 mm (23.6 in.)	\$1,877.40
MS4800S-20-0920	70230-1195	Resolution: 20 mm / Protected Height: 920 mm (36.2 in.)	\$2,556.00
MS4800S-20-1080	70230-1199	Resolution: 20 mm / Protected Height: 1080 mm (42.5 in.)	\$2,904.30
MS4800S-20-1200	70230-1202	Resolution: 20 mm / Protected Height: 1200 mm (47.2 in.)	\$3,166.20
MS4800S-30-0440	70230-1222	Resolution: 30 mm / Protected Height: 440 mm (17.3 in.)	\$1,344.60
MS4800S-30-0600	70230-1226	Resolution: 30 mm / Protected Height: 600 mm (23.6 in.)	\$1,647.90
MS4800S-30-0920	70230-1234	Resolution: 30 mm / Protected Height: 920 mm (36.2 in.)	\$2,232.90
MS4800S-30-1040	70230-1237	Resolution: 30 mm / Protected Height: 1040 mm (42.5 in.)	\$2,457.90
MS4800S-30-1200	70230-1241	Resolution: 30 mm / Protected Height: 1200 mm (47.2 in.)	\$2,758.50

#### Connection Cables

MS4800-CBLRX-10M	40451-0100	Receiver Cable, 10 meter (32.8 ft.)	\$58.50
MS4800-CBLTX-10M	40452-0100	Transmitter Cable, 10 m (32.8 ft.)	\$58.50

#### F3SJ-A Series Safety Light Curtains with No Dead Zone

- Range: 9 m (29.5 ft.) dependent on minimum object resolution and protected height
- Very compact size – 30 x 24 mm (1.18 x 0.94 in.)
- Cascaded designs possible – 4 segments, up to 400 beams
- Partial muting and position detection muting
- Cross-talk prevention



STI MODEL #	P/N	DESCRIPTION	PRICE EA.
F3SJ-A0455P20	40560-2008	Resolution: 20 mm / Protected Height: 455 mm (17.9 in.)	\$1,216.80
F3SJ-A0605P20	40560-2013	Resolution: 20 mm / Protected Height: 695 mm (27.4 in.)	\$1,437.30
F3SJ-A0905P20	40560-2023	Resolution: 20 mm / Protected Height: 905 mm (35.6 in.)	\$1,900.80
F3SJ-A1025P20	40560-2027	Resolution: 20 mm / Protected Height: 1025 mm (40.3 in.)	\$2,086.20
F3SJ-A0470P30	40560-3010	Resolution: 30 mm / Protected Height: 470 mm (18.5 in.)	\$992.70
F3SJ-A0620P30	40560-3016	Resolution: 30 mm / Protected Height: 620 mm (24.4 in.)	\$1,251.90
F3SJ-A0920P30	40560-3028	Resolution: 30 mm / Protected Height: 920 mm (36.2 in.)	\$1,752.30
F3SJ-A1045P30	40560-3033	Resolution: 30 mm / Protected Height: 1045 mm (41.1 in.)	\$1,956.60
F3SJ-A1220P30	40560-3040	Resolution: 30 mm / Protected Height: 1220 mm (48 in.)	\$2,235.60

#### Connection Cables

F39-JC7A	11034-1002	M12 Connection, 7 meter (23 ft.) length (2) cables per set	\$128.70
F39-JC3A	11034-1001	M12 Connection, 3 meter (10 ft.) length (2) cables per set	\$89.10



OMRON SCIENTIFIC TECHNOLOGIES, INC.

## SAFETY FAST TRACK PROGRAM

### Keyed Interlock Switches

#### T5009 Series Universal Tongue-Operated Safety Interlock Switch

- Strong and versatile—the compact size of the strong, glass-filled polyester housing and metal reinforced cam allows this popular switch to be used in most applications
- NEMA 6 enclosure enables these switches to withstand water washdown cleaning
- Rotatable head gives four possible actuator entry points for versatile installation
- Uses SR103, G9SA or G9SP controller shown on page 9



STI MODEL #	P/N	DESCRIPTION	PRICE EA.
T5009-021F2N	44501-0470	T5009 FLX2 2NC+1NO BBM, 3 X 1/2 NPT - Switch	\$60.30
T5009-021F1N	44501-0170	T5009 FLX1 2N/C+1NO BBM, 3 X 1/2 NPT with Flex Key - Switch	\$69.12

#### D4NS Series Tongue Interlock Safety Door Switch

- Multi-contact, labor-saving, environmentally friendly, next-generation safety-door switch
- Standardized gold-clad contacts provide high contact reliability
- Uses SR103, G9SA or G9SP controller shown on page 9



STI MODEL #	P/N	DESCRIPTION	PRICE EA.
D4NS-3AF	11027-0003	1 Conduit / Slow Action / 1NC/1NO - Switch	\$35.64
D4NS-3DF	11027-0015	1 Conduit / Slow Action / 3NC - Switch	\$36.63
D4DS-K3	11018-0013	FLEX 90° Horizontal mounting - Operation Key	\$11.70
D4DS-K5	11018-1005	FLEX Horizontal and vertical mounting - Operation Key	\$17.10

#### D4GS-N Series Tongue Interlock Slim Safety Door Switch

- Rated IP67 for water washdown
- Reversible design allows either front or rear mounting
- Slim design with a width of only 17 mm
- Built-in switch
- Operation Key with rubber mounting hole to absorb vibration and shock
- Uses SR103, G9SA or G9SP controller shown on page 9



STI MODEL #	P/N	DESCRIPTION	PRICE EA.
D4GS-N2R	11021-0025	2NC, horizontal, 1m cable - Switch	\$64.62
D4GS-NK1	11021-0045	For horizontal mounting - Operation Key	\$8.10
D4GS-NK2	11021-0046	For vertical mounting - Operation Key	\$8.10
D4GS-NK4	11021-0047	For adjustable mounting (vertical) - Operation Key	\$16.20



OMRON SCIENTIFIC TECHNOLOGIES, INC.

## SAFETY FAST TRACK PROGRAM

### Solenoid & DC Non-Contact Switches

#### D4GL Series Slim Guard Lock Safety Door Switch

- Vertically mounting guard lock safety-door switch ideal for limited installation space
- A key holding force of 1,000 N minimum
- Uses SR103, G9SA or G9SP controller shown on next page



STI MODEL #	P/N	DESCRIPTION	PRICE EA.
D4GL-4EFA-A-NPT	11020-1114	2NC/1NO+1NC/1NO Mechanical lock/24 VDC solenoid release	\$228.69
D4GL-4EFG-A-NPT	11020-1116	2NC/1NO+1NC/1NO 24 VDC solenoid lock/mechanical release	\$228.69

#### D4NL Series Guard Lock Safety Door Switch

- Best-selling guard lock safety door switch
- Key holding force of 1,300 N minimum
- Uses SR103, G9SA or G9SP controller shown on next page



STI MODEL #	P/N	DESCRIPTION	PRICE EA.
D4NL-4EFA-B-NPT	11025-0174	2NC/1NO+1NC/1; Mechanical lock/24 VDC solenoid release	\$176.22
D4NL-4EFG-B-NPT	11025-0176	2NC/1NO+1NC/1; 24 VDC solenoid lock/mechanical release	\$176.22

#### D4SL Series Small Guard Lock Safety Door Switch

- World's smallest Class 6 - contact guard lock safety door switch
- Holding force of 1,300 N
- Uses SR103, G9SA or G9SP controller shown on next page



STI MODEL #	P/N	DESCRIPTION	PRICE EA.
D4SL-3NDA-DN	11079-0126	2NC/1NO + 2NC/1NO, 1/2 -14 NPT; Mechanical lock/24 VDC solenoid release	\$186.30

#### MA Series Magnetically Actuated Safety Interlock Switches

- NEMA 6 enclosure enables the MA Series switches to satisfy most application requirements
- Long life—the MA Series is designed for a minimum of one million actuations
- Uses SR103, G9SA or G9SP controller shown on next page



STI MODEL #	P/N	DESCRIPTION	PRICE EA.
MA16DP11C3	44507-1620	MA-16 (24VDC only), 1 N/C, 1 N/O, 3 m Cable, Switch & Actuator	\$108.00
MA16DP21C3	44507-1640	MA-16 (24VDC only), 2 N/C, 1 N/O, 3 m Cable, Switch & Actuator	\$169.65

#### CM Series Non-Contact Interlock Safety Switch

- All CM switches are rated IP67
- Uses CM-S30 or G9SP controller shown on next page



STI MODEL #	P/N	DESCRIPTION	PRICE EA.
CM-S621PC5	44536-0621	CM-S621 Universal Reed Style Switch 2N/C+1N/O, 5 m Cable	\$82.62
CM-S221PC5	44536-0221	CM-S221 Universal Reed Style Switch 2N/C+1N/O, 5 m Cable	\$82.80



OMRON SCIENTIFIC TECHNOLOGIES, INC.

## SAFETY FAST TRACK PROGRAM

### Safety Relays

#### SR103AM Dual Channel Safety Monitoring Relay

- Power requirements-the SR103AM will accept 24 VAC/DC or 115 VAC
- Accepts single or dual N/C inputs or dual inputs from a light curtain
- 3 N/O outputs to route power to the coils of power contactors, plus 1 N/C auxiliary output for signaling purposes



STI MODEL #	P/N	DESCRIPTION	PRICE EA.
SR103AM01	44510-1031	SR103, 24VAC/DC, 2 inputs, 3 outputs, 1 N/C aux.	\$154.80
SR103AM02	44510-1032	SR103, 110VAC, 2 inputs, 3 outputs, 1 N/C aux.	\$267.30

#### G9SA Flexible Safety Unit

- Safety category 4; Category 3 for OFF-delay contact
- Meets Standards EN60204-1; EN954-1; UL508; CSA C22.2 No.14
- Both DIN track mounting and screw mounting are possible



STI MODEL #	P/N	DESCRIPTION	PRICE EA.
G9SA-301 AC/DC24	11054-6001	3NO+1NC, 45mm, E-stop control	\$181.71

#### SR131A Dual Channel Safety Monitoring Relay

- UL and C-UL listed, CSA and BG approved
- Conforms to EN60204-1, EN954-1, EN292, and EN1088
- External Device Monitoring (EDM) is provided with a N/C loop between Y1 and Y2



STI MODEL #	P/N	DESCRIPTION	PRICE EA.
SR131A00	44510-1310	24VDC, 1N/C + 1N/O, 2 inputs, 2 N/O outputs, 2 solid state aux	\$209.61

#### CM-S30 Control Unit

- Conforms to EN292, EN60204-1, EN954-1, EN1088, EN60947-5-3, EN947-5-3, EN50081, EN50082, EN61000-6-2, ISO 13849-1 UL and C-UL listed, TUV certified



STI MODEL #	P/N	DESCRIPTION	PRICE EA.
CM-S30	44536-0030	Control unit for 1N/C + 1N/O Reed Style Switch	\$239.67

#### G9SP Compact Programmable Safety Controller

- Cat. 4 performance level E
- Stand-alone safety controller for small and mid-sized machinery
- Easy programming for complex safety control



STI MODEL #	P/N	DESCRIPTION	PRICE EA.
G9SP-N10S	11080-0001	(10) safety inputs & (4) safety outputs	\$535.50
G9SP-N20S	11080-0003	(20) safety inputs & (8) safety outputs	\$625.50
G9SP-N10D	11080-0002	(10) safety inputs & (16) safety outputs	\$670.50



## SAFETY FAST TRACK PROGRAM

### Pulse Echo Interlock Switches

Offer increased diagnostics and series connection without loss of safety category or performance level.

#### CSS180 Pulse Echo Interlock Switch

ISO13849-1 up PLe, up to Category 4, DC=99%, CCF= >65, IEC61508 up to SIL 3, PFH=6.1x10<sup>-9</sup>

- Thermoplastic enclosure
- Electronic contact-free, coded system
- Misaligned actuation possible
- High repeat accuracy of the switching points



PART NUMBER	DESCRIPTION	PRICE EA.
CSS8-180-2P+D-M-LST	CSS180 Pulse Echo, 2 safety outputs and 1 diagnostic output, M12, 8 pole quick connect	\$157.50
CST180-1	Actuator	\$13.50
H18	Mounting block	\$4.50

#### CSS34 Pulse Echo Interlock Switch

ISO13849-1 up PLe, up to Category 4, DC=99%, CCF= >65, IEC61508 up to SIL 3, PFH=3.6x10<sup>-9</sup>

- Thermoplastic enclosure
- Electronic contact-free, coded system
- Misaligned actuation possible
- 27 mm x 108.2 mm x 35 mm



PART NUMBER	DESCRIPTION	PRICE EA.
CSS14-34-S-D-M-ST	CSS34 Pulse Echo Side Actuation, 2 safety outputs and 1 diagnostic output, M12, 8 pole quick connect	\$189.00
CST34-S-1	Actuator - side	\$22.50

#### AZM200 Pulse Echo Locking Interlock Switch

ISO13849-1 up PLe, up to Category 4, DC=99%, CCF= >65, IEC61508 up to SIL 3, PFH=4.0x10<sup>-9</sup>

- Thermoplastic enclosure
- Electronic contact-free, coded system
- Intelligent diagnosis
- 3 LEDs to show operating conditions



PART NUMBER	DESCRIPTION	PRICE EA.
AZM200SK-T-1P2P	AZM200 Pulse Echo Solenoid Interlock - 24VDC power-to-unlock, with door sensor, screw terminals	\$393.30
AZM200SK-T-1P2PA	AZM200 Pulse Echo Solenoid Interlock - 24VDC power-to-lock, with door sensor, screw terminals	\$393.30
AZ/AZM200-B30-LTAG1	LH Door Handle Actuator with Sensor	\$161.10
AZ/AZM200-B30-LTAG1P1	LH Door Handle Actuator with Sensor & Inside Release	\$225.00
AZ/AZM200-B30-RTAG1	RH Door Handle Actuator with Sensor	\$161.10
AZ/AZM200-B30-RTAG1P1	RH Door Handle Actuator with Sensor & Inside Release	\$225.00

## Emergency Stop Pushbutton

#### ADRR40RT E-Stop

- B10d=100,000



PART NO.	DESCRIPTION	PRICE EA.
ADRR40RT	E-Stop Actuator	\$32.40
AF10	1 NC Contact Block	\$5.40
AF02	1 NO Contact Block	\$5.40
MBK311/GB	Empty Single Element Enclosure - Plastic	\$38.70
MDP-8.1	Emergency Stop Plate - Plastic	\$1.80



## SAFETY FAST TRACK PROGRAM

### Electro Mechanical Interlock Switches

#### Electro Mechanical Keyed Interlock Switches

ISO13849-1 B<sub>10d</sub> - NC=2,000,000 and NO=1,000,000

- Thermoplastic enclosure
- Large wiring compartment
- Double insulated
- High level of contact reliability with low voltages and currents



PART NUMBER	DESCRIPTION	PRICE EA.
AZ16-12ZVRK	AZ16, 2NC/1NO contacts, key retention	\$74.70
AZ15/16-B1	Standard actuator key for AZ16	\$7.20
AZ15/16-B6	Flexible radius actuator key for AZ16	\$18.90

#### Electro Mechanical Locking Keyed Interlock Switches

ISO13849-1 B<sub>10d</sub> - NC=2,000,000 and NO=1,000,000

- Thermoplastic enclosure
- Interlock with protection against incorrect locking
- Double insulated
- Long life



PART NUMBER	DESCRIPTION	PRICE EA.
AZM161SK-12/12RK-024	Locking Keyed Interlock - 24VDC, power-to-unlock, 2NC/1NO on the key and 2NC/1NO on the solenoid/key, screw terminals	\$290.70
AZM161SK-12/12RKA-024	Locking Keyed Interlock - 24VDC, power-to-lock, 2NC/1NO on the key and 2NC/1NO on the solenoid/key, screw terminals	\$290.70
AZM161-B1	Standard actuating key for AZM161	\$7.20
AZM161-B6	Small radius actuating key for AZM161	\$12.60

#### Electro Mechanical Non-Contact Interlock Switches

ISO13849-1 B<sub>10d</sub> - NC and NO=25,000,000

- Thermoplastic enclosure
- Insensitive to transverse misalignment
- No mechanical wear / long life
- Insensitive to soiling



PART NUMBER	DESCRIPTION	PRICE EA.
BNS36-02Z-ST-L	Non-contact safety sensor (left door hinge) with M8 4 pole quick connect	\$75.60
BNS36-02Z-ST-R	Non-contact safety sensor (right door hinge) with M8 4 pole quick connect	\$75.60
BNS36 SPACER	Mounting spacer	\$11.70
BPS36-1	Actuator Magnet for BNS36	\$12.60
BPS36-2	Actuator Magnet 90 Degree Actuation for BNS36	\$12.60

### Door Accessories

#### CSA-M-1 Latch

- Magnetic snap lock
- For play-free interlocking of light guards



#### TFA-010

- Pre-positioning
- The actuator is independent from the centring device
- Smooth insertion or retraction of the actuator



PART NO.	DESCRIPTION	PRICE EA.
CSA-M-1	Magnetic Latch	\$8.10
TFA-010	Alignment aid for outside mounting	\$40.50



## SAFETY FAST TRACK PROGRAM

### Emergency Rope Pull Switches

#### ZQ700 Cable Pull Switch

ISO13849-1 B<sub>10d</sub> - NC=100,000

- Thermoplastic enclosure
- One-side operation / wire up to 10 m long
- Manual reset
- Position indicator



#### ZQ900 Cable Pull Switch

ISO13849-1 B<sub>10d</sub> - NC=100,000

- Metal enclosure
- One-side operation / wire up to 50 m long
- Manual reset
- Position indicator



PART NO.	DESCRIPTION	PRICE EA.
ZQ700-02	ZQ700 Cable Pull Switch, 2NC Contacts, up to 10m cable length	\$88.20
ZQ900-22-N	ZQ900 Cable Pull Switch, 2NC/2NO Contacts, up to 50m cable length with Emergency Stop	\$179.10
<b>ACCESSORIES:</b>		
STQ441-CC	Cable clamp	\$2.70
STQ441-EB	M10 eye bolt & hexnut	\$7.20
STQ441-SC	5mm Steel cable (red PVC-coated) <span style="float: right;">Price is per foot</span>	\$1.35
STQ441-SS	Stainless-Steel Spring	\$12.60
STQ441-TH	Thimble	\$3.60
S900	Tensioner	\$55.80

## Safety Monitoring Relays

#### SRB General Purpose Safety Controllers

ISO13849-1 up PLe, up to Category 4, DC=99%, CCF= >65, IEC61508 up to SIL 3, PFH=5.0x10<sup>-9</sup>

- Suitable for signal processing of potential-free outputs, e.g. emergency stop command devices, position switches and solenoid interlocks



PART NO.	DESCRIPTION	PRICE EA.
SRB301MC-24VAC/DC	Safety Monitoring Relay, 3NO/1NC contacts, fixed terminals, automatic reset, electronic fuse, 24VAC/DC	\$159.30
SRB301MA-24VAC/DC	Safety Monitoring Relay, 3NO/1NC contacts, fixed terminals, manual monitored reset, electronic fuse, 24VAC/DC	\$168.30
SRB301ST-24VAC/DC	Safety Monitoring Relay, 3NO/1NC contacts, removable terminals, automatic/manual monitored reset, electronic fuse, 24VAC/DC	\$207.90
SRB324ST-24VAC/DC	Safety Monitoring Relay, 3NO/1NC instant contacts and 2NO time delayed contacts, removable terminals, automatic/manual monitored reset, electronic fuse, 24VAC/DC	\$325.80
SRB-402EM	Output Expansion Module, 4NO/2NC contacts	\$149.40

## Input Expansion Modules

#### PROTECT IE

ISO13849-1 up PLd, up to Category 3, DC= >60%, CCF= >65, IEC61508 up to SIL 2, PFH=2.0x10<sup>-7</sup>

- Thermoplastic enclosure
- Intelligent diagnosis
- Electronic contact-free, coded system
- 3 LEDs to show operating conditions



PART NO.	DESCRIPTION	PRICE EA.
PROTECT-IE-02	Input Expansion Module, screw terminals, Input for 2NC switches	\$72.90



# Airline

## Turnkey Safeguarding Solutions and Services



### Pre-Packaged Safety Switches with Mounting Brackets and Hardware

- Designed around the Bosch Rexroth Framing product line
- Eliminate the time spent designing and manufacturing switch brackets
- Ask us about additional configurations
- In stock and ready to ship from Airline's inventory

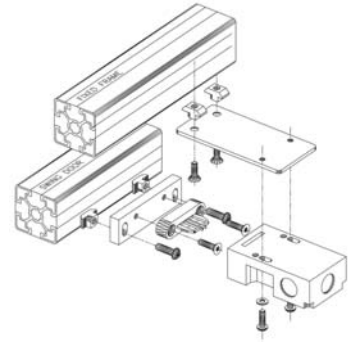

PART NUMBER	DESCRIPTION	UNIT PRICE
MIS - MSS 5FA	STI T-5009 Safety Switch Assembly, with Mounting Brackets & all Hardware	\$100.00
MIS-AZ1612AVRKA	Schmersal #AZ16-12Z-VRK Safety Switch Assembly, w/ Mounting Brackets & all Hardware	\$100.00



### MACHINE & PROCESS SAFETY ASSESSMENT GROUP Total Safety Solutions

Airline has the in-house capability to help our customers determine the safety of their work environment, identify necessary corrections, design, build and install systems and validate the results. Our cost-effective machine safeguarding solutions will reduce your liability and bring you into compliance with important safety standards.

#### Our services include:

- ▶ Machine Safety Surveys  
*Popular, low-cost alternative to full risk assessments*
- ▶ Machine Safety Risk Assessments
- ▶ ISO-13849 Standard Education and Application
- ▶ Safety Training Seminars
- ▶ Validation Services for ISO-13849 Safety Upgrades
- ▶ Consulting & Development of Corporate Safety Standards
- ▶ Minimum Safe Distance Application & Machine Stop Time Analysis
- ▶ Engineered Machine Guarding Solutions  
*Design, manufacture & installation*

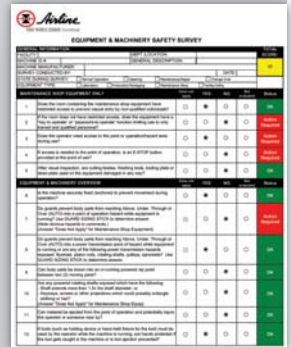

**Let Airline help you reach your objective of an injury-free environment!**

**Call 1-800-999-7378**

**www.airlinehyd.com**

**HEADQUARTERS (Southeastern PA):**  
**ISO 9001:2008 Certified**  
3557 Progress Drive, Bensalem, PA 19020  
(215) 638-4700, Fax: (215) 638-1707



**CENTRAL PA:**  
2A Interchange Place, York, PA 17406  
(717) 767-6466, Fax: (717) 764-2147

**WESTERN PA:**  
145 Delta Drive, Pittsburgh, PA 15238  
Toll Free: (877) 288-6623, Fax: (412) 963-7040

**NEW YORK STATE:**  
200 Mile Crossing Blvd., Suite 1B, Rochester, NY 14624  
Toll Free: (800) 477-9772, Fax: (800) 720-6589

**NEW ENGLAND:**  
2 Sterling Road, Unit 2C, N. Billerica, MA 01862  
Toll Free: (866) REXROTH, Fax: (978) 353-3084

**MARINE & MOBILE SYSTEMS:**  
428 Woodbine-Ocean View Rd., Ocean View, NJ 08230  
Toll Free: (877) MARINE-2, Fax: (609) 624-0863

**LEHIGH VALLEY, PA:**  
(610) 758-9400, Fax: (610) 758-9444

**NORTH JERSEY/NEW YORK CITY:**  
Toll Free: (888) 842-5493, Fax: (732) 346-3177

**BALTIMORE, MD:**  
(410) 574-5200, Fax: (410) 574-1141

**FLUID POWER AUTOMATION:**  
ISO 9001:2008 Certified  
376 Dry Bridge Road, Bldg. B-1, N. Kingstown, RI 02852  
(401) 583-0190, Fax: (401) 583-0191



Bosch Rexroth's aluminum structural framing can be easily reconfigured and repurposed, reducing what ultimately would end up in a landfill. As a matter of fact, aluminum has emerged as the most environmentally sustainable material available to our increasingly resource-conscious planet.



**Airline**  
100% Employee Owned

**Call 1-800-999-SERV (7378)**

Rev. 9/11

**www.airlinehyd.com**