

## FluidEngineering and Service – worldwide.

### Fluid Management.

Contaminated, used or incorrect fluids lead to significantly increased operating costs because of premature component failure and reduced system availability. HYDAC provides solutions for fluid handling and for customised fluid management programmes. Mobile fluid laboratory vehicles are at your service locally and worldwide.

### Application examples.

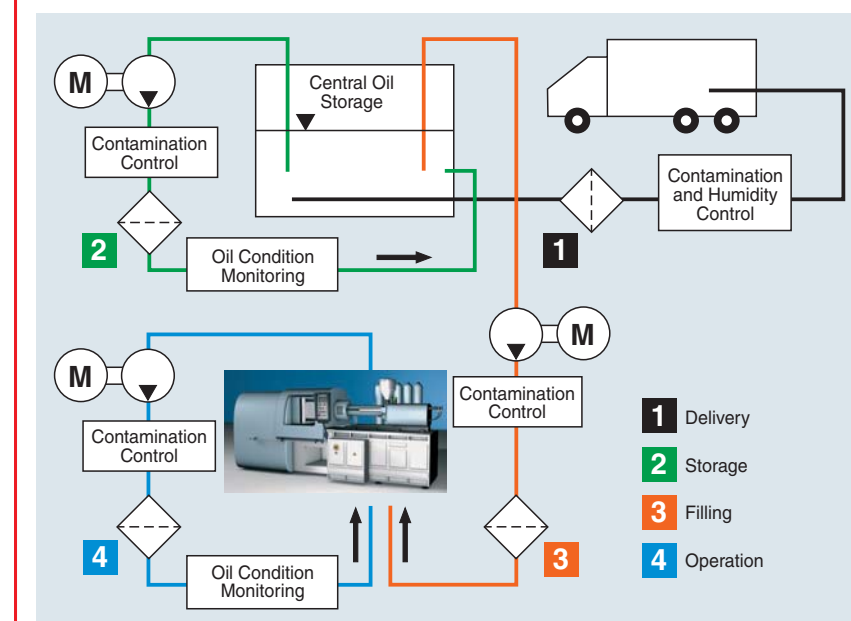

### Analysis and Diagnosis.

Measurement and analysis instruments for monitoring components and machine cleanliness. Data recording and evaluation systems are available to monitor both individual machines and systems. Interface modules allow maximum integration with existing systems.

### Optimisation.

A range of stationary and mobile filtration units with or without water separation enables customised designs to be built whilst having regard to existing installations.

### Commissioning.

Trained partners provide on-site support when commissioning systems.

### Maintenance.

Individual maintenance according to customer requirements or a support service for maintenance tasks can also be provided.



Global presence. Local expertise. [www.hydac.com](http://www.hydac.com)



● HYDAC Headquarters  
● HYDAC Companies  
● HYDAC Distributors and Service Partners

**HYDAC INTERNATIONAL**

Head Office  
 HYDAC INTERNATIONAL  
 GMBH  
 Industriegebiet  
 66280 Sulzbach/Saar  
 Germany  
 Phone:  
 +49 (0)6897/509-01  
 Fax:  
 +49 (0)6897/509-577  
 Internet: [www.hydac.com](http://www.hydac.com)  
 E-Mail: [plastic@hydac.com](mailto:plastic@hydac.com)

**HYDAC INTERNATIONAL**

Components, Systems and Service for Plastic Injection Moulding Machines.

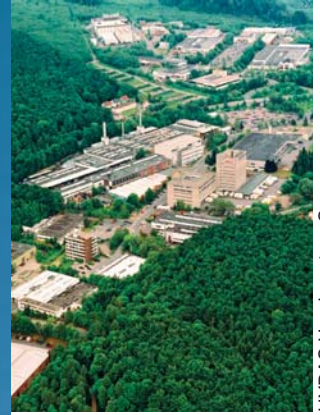

**HYDAC**

Your Professional Partner for Plastic Injection Moulding Machines.

With over 4,000 employees worldwide, HYDAC is one of the leading suppliers of fluid technology, hydraulic and electronic equipment.

Our wide range of products, combined with our expertise in development, manufacturing, sales and service enables the manufacturers of plastic injection moulding machinery worldwide to overcome the most diverse problems.

Our quality and environment certification to ISO 9001/2000 and ISO 18001 denote first class quality and responsible management of our resources.

### Global yet local.

With 40 overseas subsidiaries and over 500 distributors and service partners, HYDAC is your reliable partner worldwide.

### Solution packages. One supplier. One contact.

Wherever you need us, we are here to help you find the most effective solution – for every application, from components to a complete system.

### Worldwide specifications and approvals.





## HYDAC in Plastic Injection Moulding Machines.

From the components to the system  
Whether in hydraulics or cooling

Your demands are our challenge:  
Optimising costs by means of customised system solutions  
whilst using standard components

Reduction of the number of parts  
by means of standardisation and modular construction  
Active co-operation in a close development partnership  
Worldwide service and global commercial agreement

### Condition Monitoring and Sensor Technology

Pressure transmitters with highly accurate and robust sensor cells consisting of a thin-film strain gauge on stainless steel membrane.

Special features:  
- high overload protection  
- excellent repeatable accuracy  
- long service life, also with high load cycle frequency  
- temperature stability  
- excellent EMC characteristics

Temperature and fluid level sensors and switches to provide feedback for the machine control system on process or machine parameters and conditions.

Oil condition and cleanliness sensors enable condition-based maintenance to be carried out and ensure machine availability.

Possible applications:  
- original equipment manufacture  
- retrofit  
- customer service  
Electronic components for linking and evaluating the sensors

### Pressure Transmitter



Pressure Transmitter HDA 4700

### Fluid Level



Electronic Level Gauge ENS 3000

### Oil Ageing

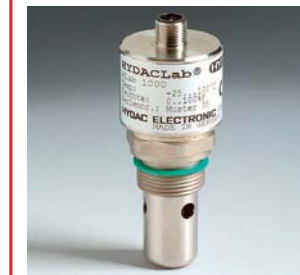

HYDACLab® HLB 1000 Oil Ageing Sensor

### Particle Contamination in Oil



ContaminationSensor CS 1000 Cleanliness to ISO 4406 and SAE 4059.

### Water Content in Oil



AquaSensor AS 1000, relative water content

### Particle / Water in Oil



FluidMonitoring Modul FMM, (Combination of AquaSensor AS 1000 / ContaminationSensor CS 1000).

### Particle Contamination in Oil



FluidControl FCU 2000 (mobile data recording).

### Mobile Data Systems



Portable Data Recorder HMG 3000 (10 input channels) also for reading data from condition monitoring sensors (offline).

### Sensor Interfaces



ConditionMonitoring Unit CMU 1000 for recording, manipulating and evaluating measured data.

### Hydraulic Oil Filtration

Good cleanliness in the hydraulic oil is required to achieve a long lifetime of the hydraulic components and the hydraulic oil itself. The design of the hydraulic components with their sensitivity regarding solid particles is an important fact when determining the appropriate filtration technology. The filtration concept has to be adapted to the hydraulic and mechanical design of the machine and to be monitored. Hydraulic systems using pumps with high dynamic flow and pressure changes, need specially developed filter elements and housings to withstand fatigue load. A complete selection of filter housings, elements and clogging indicators is available.

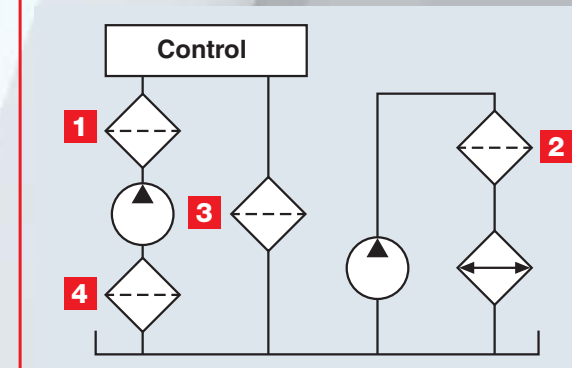

Circuit diagram for filtration



Inline Filters LF or DF



Offline Filters NF



Return Line Filters RF



Suction Strainers SF

### Filter Systems

Units for filling, transfer and filtration of hydraulic fluids for reliable commissioning and maintenance  
Monitoring oil cleanliness during commissioning and servicing at regular intervals using mobile units  
Permanently installed offline filtration units to optimise oil cleanliness.  
Water removal



Offline Filters OLF with Dimicron Elements



Offline Filters OLF Compact

Offline Filter OLF 5, mobile

### Filter-Cooler Systems

Integral filtration and cooling units with flange-mounted motor-pump units:  
- for optimum customisation  
- as built-in solutions or complete power packs  
Compact products, optimised for function, without external connection lines  
- leakage-free  
- cost-effective  
- tailored to the installation space



Filter Cooler System FKEM for in-tank mounting



Pump-Transfer Cooler Filtration Unit UKF

### Cooling Systems

A stable operating temperature is fundamental to optimum machine operation. To cool the hydraulic fluid or the electrical components of servo-drives, suitable heat exchangers (using HYDAC circulation pumps) are built into the machine.



Circulation Pumps for filtration / cooling circuits.



Plate Heat Exchangers



Cooler Unit FWKS for cooling electrical drives.

### Gas Injection Systems

Complete power packs to perform hydraulic functions such as:  
- hydraulic core pull and valve gate nozzle functions in machine tools on fully electrically powered machines  
- to drive another injection unit



### Hydraulic Systems and Controls

#### Cartridge Valves

Fast switching valves, e.g. to pressurise and depressurise hydraulic force on the movable platen of the clamp  
Proportional valves e.g. to charge and discharge accumulators.  
Safety relief valves to limit the maximum hydraulic pressure in the system.



#### Hydraulic power units, e.g. to operate

Core pulling  
Needle closing  
Nozzle movement  
as an auxiliary hydraulic unit for electromechanically driven plastic injection moulding machines or to drive an additional injection unit.



### Hydropneumatic Accumulators

Bladder, piston and diaphragm type accumulators are used in plastic injection moulding machines, e.g. for

High speed plastic injection, to manufacture thinwall packaging parts.  
Parallel operation of different functions or movements to reduce the necessary cycle time.  
Reducing the installed power by using the energy storage possibility.  
Pulsation dampeners and silencers reduce noise emission by dampening the pressure pulsations in the hydraulic system.

Adaptable accumulator charging systems to optimise the energy consumption  
Load sensing accumulator charging and self optimising system pressure adaption.  
Proportional pressure control for the pump loading / bypass switching.  
Safety devices to complete the accumulator systems:  
Fuse plugs  
Burst discs  
Gas safety valves  
Safety and shut-off blocks  
Pressure relief valves



Hydropneumatic Accumulators and Silencers Volume 0.075 l to 1200 l Nominal pressure 16 bar to 550 bar.



Accumulator station

### Accessories

Components for completing hydraulic systems  
Mounting elements for components and pipework (ISO standard components or customised design)  
Fluid level gauges and Fluid level sensors  
Shut-off ball valves  
Bell housings, couplings and damping elements

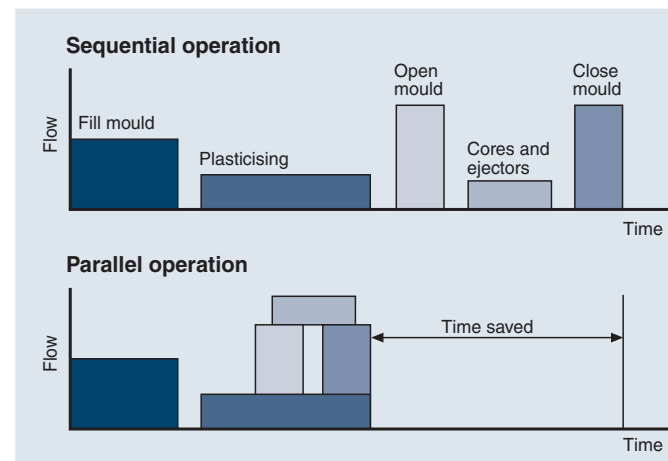

Cycle time reduction by means of parallel operation when using accumulators

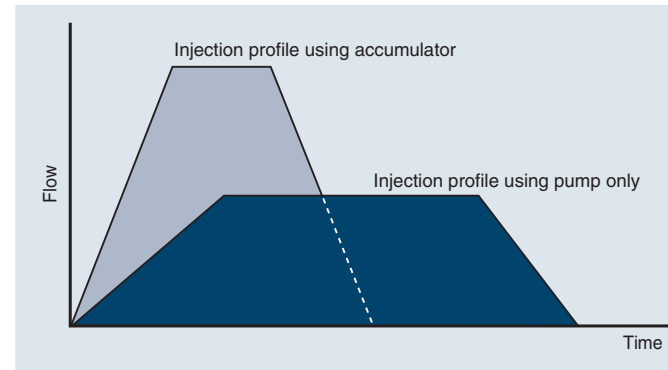

Cycle time reduction by using an accumulator

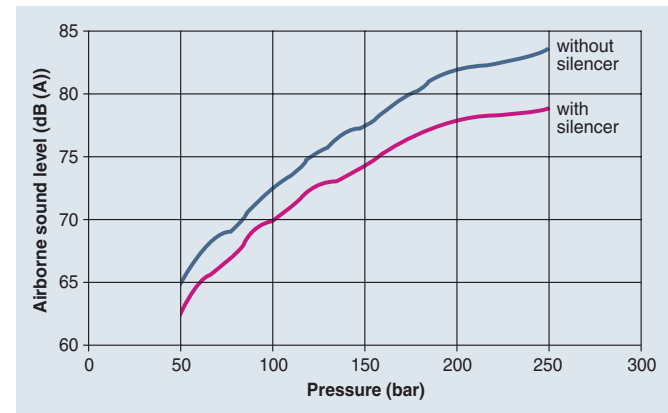

Noise reduction by the use of pulsation damping