

# DIAX03 Drive With Main Spindle Function SERCOS interface

Version Notes: SHS 03VRS

	DIAX03
<b>Title</b>	Drive With Main Spindle Function, SERCOS interface
<b>Type of Documentation</b>	Firmware-Version Notes: SHS-03VRS
<b>Document Typecode</b>	DOK-DIAX03-SHS-03VRS**-FV01-EN-P
<b>Internal File Reference</b>	<ul style="list-style-type: none"> <li>• Box 52-03-EN</li> <li>• 120-0700-B306-01/EN</li> <li>• Based on: SSE: 03VRS</li> </ul>
<b>Purpose of Documentation</b>	<p>The following documentation is a complement to the description of functions DOK-DIAX03-SHS-03VRS**-FK01-EN-P</p> <p>It describes the differences between DIAX03-SHS-03VRS and DIAX03-SHS-02VRS.</p> <ul style="list-style-type: none"> <li>•</li> </ul>

**Record of Revisions**

Description	Release Date	Notes
DOK-DIAX03-SHS-03VRS**-FV01-EN-P	03.2000	02VRS -> 03VRS

**Copyright** © 2000 Rexroth Indramat GmbH

Copying this document, giving it to others and the use or communication of the contents thereof without express authority, are forbidden. Offenders are liable for the payment of damages. All rights are reserved in the event of the grant of a patent or the registration of a utility model or design (DIN 34-1).

**Validity** All rights are reserved with respect to the content of this documentation and the availability of the product.

**Published by** Rexroth Indramat GmbH  
Bgm.-Dr.-Nebel-Str. 2 • D-97816 Lohr a. Main  
Telephone 09352/40-0 • Tx 689421 • Fax 09352/40-4885  
<http://www.rexroth.com/indramat>  
Dept. ECD1 (HP/GF)

**Note** This document has been printed on chlorine-free bleached paper..

## Summary of Documentation - Overview

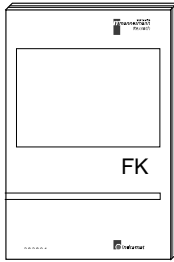

**Functional Description:**

Description of all implemented Function based on SERCOS-Parameters

Order designation:  
DOK-DIAX03-SHS-03VRS\*\*-FK01-EN-P

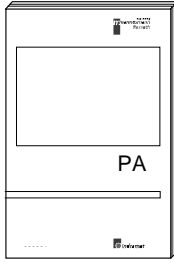

**Parameter Description:**

A description of all parameters used in the firmware

Order designation:  
DOK-DIAX03-SHS-03VRS\*\*-PA01-EN-P

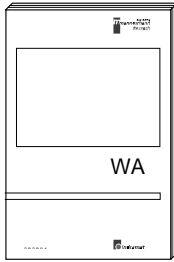

**Troubleshooting Guide:**

-Explanation of the diagnostic states  
-How to proceed when eliminating faults

Order designation:  
DOK-DIAX03-SHS-03VRS\*\*-WA01-EN-P

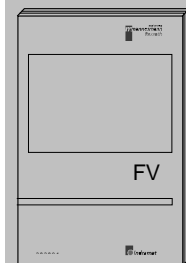

**Firmware Version Notes:**

Description of new and changed functions in terms of the derivatives:

-FWA-DIAX03-SHS02VRS-MS

Order designation:  
DOK-DIAX03-SHS-03VRS\*\*-FV01-EN-P

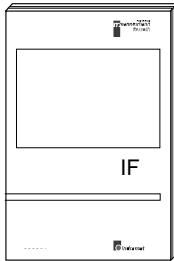

**Drive Configuration:**

-Determining the motor type  
-Choosing the motor – motor feedback combination  
-Choosing the desired function of the drive control device

Order designation:  
DOK-DIAX03-SHS-03VRS\*\*-IF01-EN-P



**CD: DRIVEHELP**

Collection of Windows help systems which contain documents on firmware derivatives

Order designation:  
DOK-GENERL-DRIVEHELP\*\*-GExx-MS-D0600

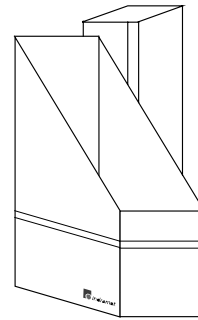

Order designation  
DOK-DIAX03-SHS-03VRS\*\*-5201-EN-P

## Notes

# Contents

<b>1</b>	<b>General Information</b>	<b>1-1</b>
1.1	Product Family .....	1-1
1.2	Documentation .....	1-1
1.3	Notes on Replacing the Firmware.....	1-2
<b>2</b>	<b>Firmware Version Notes FWA-DIAX03-SHS-03VRS-MS</b>	<b>2-3</b>
2.1	Release notes .....	2-3
2.2	EPROM Labeling .....	2-3
2.3	New Basic Functions.....	2-4
	Base Parameters and Loading Base Parameters .....	2-4
	Error Memory and Operating Hour Counter .....	2-4
	IDN List of Parameters.....	2-4
	List of Last Diagnoses Numbers .....	2-5
	Multiplex Channel .....	2-5
	Automatic Detection of Indramat Housing Motors .....	2-5
	Rotary Synchronous Kit Motors .....	2-5
	Synchronous Motors with Incremental Measuring Systems.....	2-5
	Fieldweakening for Synchronous Motors.....	2-6
	Command „B0 Open motor holding brake“ .....	2-6
	Brake as Servo or Main Spindle Brake.....	2-6
	Position Control with Command Values greater than Possible with Mechanical Revolution ..	2-6
	Accel Pre-Control.....	2-6
	Choice of linear or cub position command value interpolation in position control.....	2-7
	Function Selection of Encoder 2 .....	2-7
	Settable Drive-Internal Illustration of the Position Data .....	2-7
	Command Determine Marker Position.....	2-8
	Command Clear Home Reference .....	2-8
	Taking Cooling Mode Into Account when Standardizing Torque/Force Data.....	2-8
	New Parameters for Status Display for E-Stop Input .....	2-9
	Filter for Actual Velocity Value .....	2-9
	Command Parking Axis .....	2-9
	Intelligent Safety Technologies (IST).....	2-9
	Monitoring Current Measurement Trim.....	2-10
2.4	Expanded/Changed Functions.....	2-11
	Parameter Attributes .....	2-11
	Expanding Parameter S-0-0013, Class 3 diagnostics .....	2-11
	Expansion of parameter S-0-0182 Manufacturer class 3 diagnostics .....	2-11
	Compatibility Class B of SERCOS interface.....	2-11

Percent Velocity Window .....	2-11
Selecting Language for Diagnoses and Parameters .....	2-12
Torque / Force Control with Command Value Filter .....	2-12
Velocity Control Loop Monitor - Deactivation.....	2-12
Altered and New Applications of Encoders as Motor Encoders .....	2-12
Load-side Motor Encoder.....	2-13
Absolute Encoder Evaluation and Monitoring of 2 Absolute Measuring Systems.....	2-13
Expanded E-Stop Input Function.....	2-13
Configuration Power Shutdown with Fault and Undervoltage .....	2-14
Controller Structure.....	2-15
Velocity Control Loop.....	2-16
Drive Halt .....	2-16
Drive-Controlled Homing.....	2-16
Homing Absolute Measuring Systems with Positioning to Home.....	2-16
Expanding Parameter S-0-0403, Position feedback value status .....	2-17
Configurable Signal Status Word.....	2-17
Analog Output .....	2-17
Analog Inputs .....	2-17
Digital I/Os.....	2-18
Command Spindle Positioning.....	2-18
Gear Switching.....	2-18
Communication via Serial Interface Phased-Out.....	2-18
2.5 New Parameters .....	2-19
2.6 Expanded/Altered Parameters.....	2-22
2.7 Deleted Parameters .....	2-22
2.8 New Diagnoses .....	2-23
2.9 Diagnoses Removed.....	2-24

**3 Kundenbetreuungsstellen - Sales & Service Facilities 3-1**

# 1 General Information

## 1.1 Product Family

The product release description refers to the product family:

**DIAX03**  
 Drive With Main Spindle Function,  
 SERCOS interface  
 FWA-DIAX03-SHS-03VRS-MS

The following drive controls can be operated with this software

The released firmware applies to the following drive controllers:

DKR03.1-W100	DKR03.1-W150	DKR03.1-W200	DKR03.1-F100
DKR03.1-F150	DKR03.1-F200	DKR02.1-W200	DKR02.1-W300
DKR02.1-F200	DKR02.1-F300	DKR04.1-W300	DKR04.1-W400
DKR04.1-F300	DKR04.1-F400	DDS02.2-W015	DDS02.2-W025
DDS02.2-W050	DDS02.2-W100	DDS02.2-W150	DDS02.2-W200
DDS02.2-A015	DDS02.2-A050	DDS02.2-A100	DDS02.2-A200
DDS02.2-F015	DDS02.2-F050	DDS02.2-F100	DDS02.2-F200
DDS03.2-W015	DDS03.2-W030	DDS03.2-W050	DKR05.1-W400
DKR05.1-W600	DKR05.1-W800		

## 1.2 Documentation

The documentation for product **FWA-DIAX03-SHS-03VRS** is available as follows:

- Paper form
- Windows help system

The following table contains a summary of available items.

POS	Type	Document style	Part number	Symbol number
1	DOK-DIAX03-SHS-03VRS**-5201-EN-P	Box	284082	120-0700-B308-01
2	DOK-DIAX03-SHS-03VRS**-FK01-EN-P	Functional Description Paper	284073	120-0700-B303-01
3	DOK-DIAX03-SHS-03VRS**-PA01-EN-P	Parameter Description Paper	284075	120-0700-B304-01
4	DOK-DIAX03-SHS-03VRS**-IF01-EN-P	Drive Configuration Paper	284078	120-0700-B307-01
5	DOK-DIAX03-SHS-03VRS**-WA01-EN-P	Troubleshooting Guide Paper	284076	120-0700-B305-01
6	DOK-DIAX03-SHS-03VRS**-FV01-EN-P	Firmware Version Notes Paper	284077	120-0700-B306-01
7	DOK-GENERL-DRIVEHELP**-GN03-MS-D0600	Drivehelp	282411	120-1300-B302-***

Fig. 1-1: Document for FWA-DIAX03-SHS-03VRS

## 1.3 Notes on Replacing the Firmware

Prior to replacing the firmware, the following points must be noted:

- Read the entire documentation
- Store the current set of parameters

---

**Note:** The parameters that are to be secured are stored in parameter **S-0-0192, IDN list of backup operation data.**

---

- Switch drive controller off and replace software module
- Load the parameters back in
- Check the functions



## 2 Firmware Version Notes FWA-DIAX03-SHS-03VRS-MS

### 2.1 Release notes

Firmware version **FWA-DIAX03-SHS-03V13** represents the first official edition of version 03. It was released on **August 06.1999**.

The following drive controllers can be operated with the released software:

DKR03.1-W100	DKR03.1-W150	DKR03.1-W200	DKR03.1-F100
DKR03.1-F150	DKR03.1-F200	DKR02.1-W200	DKR02.1-W300
DKR02.1-F200	DKR02.1-F300	DKR04.1-W300	DKR04.1-W400
DKR04.1-F300	DKR04.1-F400	DDS02.2-W015	DDS02.2-W025
DDS02.2-W050	DDS02.2-W100	DDS02.2-W150	DDS02.2-W200
DDS02.2-A015	DDS02.2-A050	DDS02.2-A100	DDS02.2-A200
DDS02.2-F015	DDS02.2-F050	DDS02.2-F100	DDS02.2-F200
DDS03.2-W015	DDS03.2-W030	DDS03.2-W050	DKR05.1-W400
DKR05.1-W600	DKR05.1-W800		

### 2.2 EPROM Labeling

EPROM IC2:

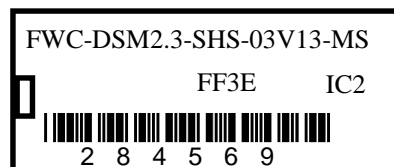

EPROM IC3:

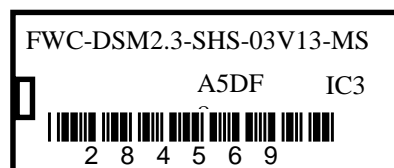

## 2.3 New Basic Functions

### Base Parameters and Loading Base Parameters

The drive parameters are fixed at delivery with base values set at the factory. By running command **P-0-4094, C800 Command Base-parameter load** it is possible to reproduce this state at any time. The base parameter block is built up so that

- all important monitors are activated
- all optional drive functions deactivated
- limit values for position deactivated
- limit values for torque/force are set to high values and
- limit values for velocity and acceleration set to low values.

#### Automatic running of function „Load base parameter block“

The drive firmware is on the programming module. Given a firmware exchange to another compatible firmware version, then the drive controller will detect this change the next time the control voltage is switched on. In this case, "PL" appears on the display.

By pressing the "S1" key, the „Load base parameter block“ function is activated.

### Error Memory and Operating Hour Counter

**Error memory** If occurring errors are deleted, then these are written into an error memory. This memory contains the last 18 errors and the time they occurred. Errors resulting from the shutdown of the control voltage (e.g., F870 +24 volt error) are not recorded.

**Operating hour counter** An operating hour counter also exists for the control and power sections of the drive controllers. The following parameters are intended for this function

- **P-0-0190, Operating hours control section**
- **P-0-0191, Operating hours power section**
- **P-0-0192, Error recorder, diagnosis number**
- **P-0-0193, Error recorder, operating hours control section**

### IDN List of Parameters

There are parameters in the drive that contain ID numbers of drive parameters. These support the handling of drive parameters by means of a parametrization program (e.g., DriveTop). The following lists have been added:

- **S-0-0018, IDN list of operation data for CP2**
- **S-0-0019, IDN list of operation data for CP3**
- **S-0-0025, IDN list of all procedure commands**
- **S-0-0026, Configuration list signal status word**
- **S-0-0192, IDN list of backup operation data**
- **S-0-0292, List of all operating modes**
- **S-0-0328, Assign list signal status word**
- **S-0-0370, Configuration list for MDT data container**

- **S-0-0371, Configuration list for the AT data container**
- **S-0-0375, List of diagnostic numbers**
- **P-0-0194, List of present plug-in modules**
- **P-0-0426, Analog outputs, IDN list of assignable parameters**

## List of Last Diagnoses Numbers

The last 50 diagnoses of the drive (**S-0-0390, Diagnostic message number**) are stored in parameter **S-0-0375, List of diagnostic numbers**.

## Multiplex Channel

The firmware supports cyclic data transmission of various freely-configurable parameters into the data container of the transmission telegrams. To do this, lists of the parameters to be transmitted are generated for the MDT and AT. This is processed step by step via an index that is specified by the control. For each transmission cycle, the parameter specified via the index is transmitted to the relevant list via the data container of the MDT or AT.

## Automatic Detection of Indramat Housing Motors

The introduction of parameter **P-7-4014, Motor type** into the feedback data memory has made it possible to automatically detected an Indramat housing motor independent of motor designation **S-7-0141, Motor type**. Parameter **P-7-4014** is used to identify the motor if it is stored in the feedback data memory and is larger than zero.

## Rotary Synchronous Kit Motors

Firmware supports rotary synchronous kit motors. To do this, a 7 must be entered in parameter **P-0-4014, Motor type**.

All motor parameters such as number of pole pairs, peak and standstill currents have to be set with the help of parameter lists from the motor manufacturer. They are not automatically read out of the feedback.

The commutation settings are made when mounted.

## Synchronous Motors with Incremental Measuring Systems

Synchronous motors can be operated with incremental measuring systems with this firmware. With the initial drive enable ("Ab" => "AF") the commutation angle is automatically determined and available from then on until the measuring system is re-initialized. The following encoder systems can be used:

- Incremental sine encoder,  $\mu\text{A}$  level
- Incremental sine encoder, 1 Vpp level
- Incremental square-wave encoder, 5V-TTL
- Indramat gearwheel encoder
- gearwheel encoder with 1 Vpp level

---

**Note:** It is possible that the drive could move while determining the commutation angle.

---

## Fieldweakening for Synchronous Motors

Fieldweakening mode has been used with synchronous motors. This means that these motors can be operated with constant power (fieldweakening range). This range begins just above the peak speed. Until now it was only possible to operate synchronous motors up to peak speed in the area of constant torque (basic velocity range).

## Command „B0 Open motor holding brake“

By starting command **P-0-0542, B100 Command Open motor holding brake** it is possible to open the motor brake.

## Brake as Servo or Main Spindle Brake

The behaviour of an existing motor brake can be selected as servo or main spindle brake. Use parameter **P-0-0525, Type of motor brake** to do this.

## Position Control with Command Values greater than Possible with Mechanical Revolution

The modulo value parameter is no longer restricted to its input values. It is now possible to enter modulo values greater than a mechanical revolution. This means that in position control greater position command value differences can be entered to achieve a higher travel velocity with the same NC cycle time.

To run the drive-internal travel command (e.g., spindle positioning) modulo with one revolution can be set with parameter **S-0-0294, Divider for modulo value**.

## Accel Pre-Control

Applications requiring the highest precision at the highest speeds now have the option of increasing the precision of an axis during the accel and decel phases by activating an accel precontrol.

Parameter **S-0-0348, Acceleration feedforward gain** is used to set this precontrol.

## Choice of linear or cub position command value interpolation in position control

The firmware is outfitted with two position command value interpolators that can be alternately activated. With linear interpolation, the programmed position command values are already reached in the following cycle in the position controller. Velocity and accel precontrol work with jumps. The cubic interpolator reaches the command values two cycles later. Cubic interpolation makes the precontrol (velocity and accel precontrol) steady.

## Function Selection of Encoder 2

An optional encoder mounted to the drive can be used for different purposes. The evaluation mode is set in parameter **P-0-0185, Function of encoder 2**.

Value in P-0-0185, Function of encoder 2	Definition
0	Optional encoder as additional load-side control encoder for position and/or velocity control loops
2	Optional encoder as stand-alone load-side control encoder (only with rotary asynchronous motors)
4	Optional encoder as spindle encoder. Treated like "optional encoder as auxiliary load-side control encoder for position and/or velocity control loops". If maximum possible signal frequency is exceeded, then no error is generated but rather the position status is only cleared.

## Settable Drive-Internal Illustration of the Position Data

There are two different forms in the drive used to illustrate the position data. There is

- a **display format**
- and a **drive-internal format**.

The **display format** defines the unit, i.e., the LSB value, with which the position data between drive and control/surface are exchanged.

The **drive-internal format** determines the LSB value with which the position command and actual values are prepared as well with which the position control loop in the drive is closed. The values of parameters

- **S-0-0278, Maximum travel range**
- **S-0-0116, Feedback 1 Resolution** and
- **S-0-0256, Multiplication 1**.

are used by the drive to compute the drive-internal format.

For drive-internal resolution it applies:

$$\text{Resolution} = \text{encoder resolution} \times \text{multiplication}$$

Resolution:	drive-internal resolution of pos. data [Incr/rev]
Multiplication:	value in S-0-0256 or S-0-0257 [Incr/TP]
Encoder resolution:	value in S-0-0116 or S-0-0117 [TP/lrev]

The format of the drive-internal position data effects the maximum limit accel that can be given to the interpolator.

The following applies :

$$a \max = \frac{51.471.854.040}{\text{enc. resolution} \times \text{multiplication}} \left[ \text{in } \frac{\text{rad}}{\text{sec}^2} \right]$$

amax:	maximum accel of position command value interpolator
Encoder resolution:	value in S-0-0116
Multiplication:	value in S-0-0256

## Command Determine Marker Position

This command supports

- the checking for erroneous detection of the homing marker of an incremental measuring system or
- determining the position of the homing marker if the homing procedure was conducted by the control. In this case, this information is used to switch the coordinate system in the control.

A homing switch evaluation is not conducted with this command.

For this function, there are the following parameters.

- **S-0-0173, Marker position A**
- **P-0-0014, D500 Command determine marker position**

## Command Clear Home Reference

The clear home reference command is built in. By starting the command, bit **S-0-0403, Position feedback value status** is cleared in the drive.

## Taking Cooling Mode Into Account when Standardizing Torque/Force Data

The different ways to cool the motor effect the standstill and nominal currents of the motor. All torque/force data are scaled in percent and relate to the standstill or nominal current of the motor. To get correct torque/force data for the various cooling modes, the cooling mode is taken into account when standardizing.

Parameter **P-0-0640, Cooling type** is used to define a factor to specify the increase of the standard or nominal current.

Cooling	Parameter value	Factor
not cooled	0	100 %
cooled	1	150 %
water cooled	2	190 %

This is taken into account when standardizing torque/force data.

---

**Note:** The nominal or standstill current in parameter S-0-0109 is not switched so that the cooling type factor must be considered when determining the physical torque.

---

## New Parameters for Status Display for E-Stop Input

When diagnosing, the E-Stop input can be read out via **P-0-0223, Status Input E-Stop function**.

## Filter for Actual Velocity Value

Via **P-0-0538, Motor function parameter 1** an 8 msec filter can be activated for parameter **S-0-0040, Velocity feedback value**. The filter only works for the H1 display, however.

## Command Parking Axis

The command "Parking axis" supports the operational coupling of an axis. This can be needed if an axis is temporarily standing still, for example. Starting the command means that all monitors are switched off that belong to the measuring system and the control loops.

There is the following parameter for this function: **S-0-0139, D700 Command Parking axis**.

## Intelligent Safety Technologies (IST)

The firmware is outfitted with a function packet that supports personnel protection. This defines the following functions:

- a safe stop
- safe operating halt
- safe reduced velocity 1 with safely limited absolute position 1
- safely reduced velocity 2 with safely limited absolute position 2
- 4 safe cams (position switching points)

---

**Note:**     **Function IST cannot be switched with SHS03V10.** Only the parameters needed for IST have been installed for re-equipping in later firmware releases with certified IST functions without loss of parameters.

---

## Monitoring Current Measurement Trim

The current measurement trim is monitored. If the zero point lies within a range where the maximum current is outside of the measuring range of the current measuring system, then error **F277 Current measurement trim wrong** is generated.



## 2.4 Expanded/Changed Functions

### Parameter Attributes

The attributes of the parameters have been expanded. The communications phase of the parameter that can be write accessed is now displayed.

### Expanding Parameter S-0-0013, Class 3 diagnostics

The following bits are now supported in parameter S-0-0013:

**Bit 2** |Velocity feedback value (S-0-0040)| < Velocity threshold nx(S-0-0125)

**Bit 4** | Md | ≥ Bipolar torque/force limit value ( S-0-0092 )|

**Bit 12** *Target position*  
Internal position command value = Target position (S-0-0258)

No longer supported:

**Bit 5**  $|n_{\text{soll}}| > n_{\text{grenz}}$ ,  
the velocity command value (S-0-0036) is outside of the velocity limitations  $\pm n_{\text{grenz}}$  (S-•-0091)

### Expansion of parameter S-0-0182 Manufacturer class 3 diagnostics

The following bits are now supported in parameter S-0-018:

**Bit 1** |Velocity feedback value (S-0-0040)| < S-0-0124, Standstill window

**Bit 6** *IZP*  
*with active interpolation operating mode:*  
| S-0-0258, Target position - Istpos. | < S-0-0057, Position window  
&&  
|S-0-0189, Following error| < S-0-0057, Position window  
&&  
|S-0-0040, Velocity feedback value| < S-0-0124, Standstill window

**Bit 10** *IN\_ZIELPOSITION*  
*with active interpolation operating mode:*  
|S-0-0258, Target position - S-0-0051/53, Position feedback 1/2 value|  
< S-0-0057, Position window

### Compatibility Class B of SERCOS interface

The firmware now contains the demands made of compatibility class B of the SERCOS interface.

### Percent Velocity Window

To generate the status message N=N<sub>soll</sub> a percent velocity window can now be entered. Use parameter **S-0-0272, Velocity window as percentage**.

## Selecting Language for Diagnoses and Parameters

The language options have been expanded with the following now available:

- German
- English
- French
- Spanish
- Italian

## Torque / Force Control with Command Value Filter

The VZ1 filter for torque control smoothing of the torque command values has been altered in the firmware. The filter time constant is no longer set in parameter **P-X-1222, Velocity command filter** but rather parameter **P-X-0176, Torque/Force command smoothing time constant**.

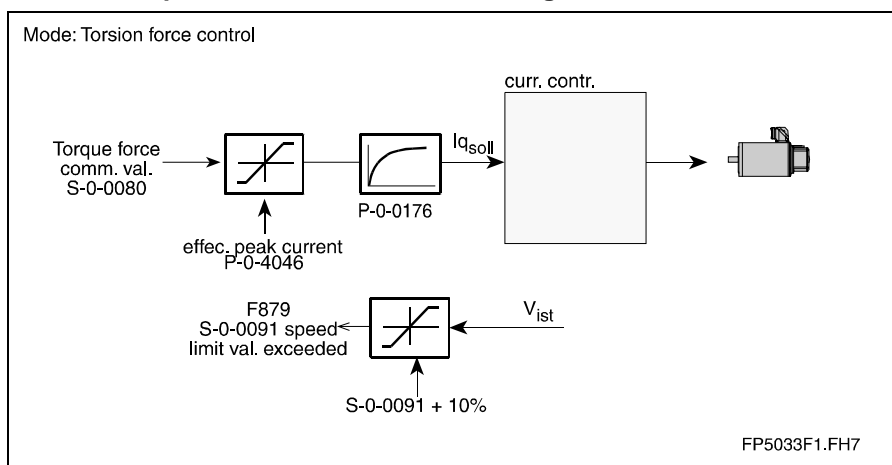

Fig. 2-2: torque / force control

## Velocity Control Loop Monitor - Deactivation

The velocity control loop monitor can be deactivated with parameter **P-0-0538, Motor function parameter 1**. Only deactive in exceptional cases.

## Altered and New Applications of Encoders as Motor Encoders

For firmware SHS03 new encoder systems have been introduced as motor encoders or then can now be used with other motors as well.

Motor types with parametrizable encoder interfaces can be used with the following measuring systems.

Measuring system	Encl. interface	Value in P-0-0074	for synchronous motors	for asynchronous motors
digital servo feedback (DSF,HSF) or resolver	Standard	1	yes	yes
Incremental enc. with sine signals from Heidenhain (1V – signals)	DLF 01.1M	2	no	yes
Indramat gearwheel encoder	DZF 02.1M	3	no	yes
Incremental enc. with square-wave signals from Heidenhain (not recommended)	DEF 01.1M	5	no	yes
Encl. with EnDat interface from Heidenhain	DAG 01.2M	8	yes	yes
Gearwheel encoder with 1Vss signals	DZF 03.1M	9	no	yes
Resolver without feedback memory	Standard	10	yes	no
Resolver without feedback data memory + incremental enc. with sine signals	Standard + DLF01.1	11	yes	no

## Load-side Motor Encoder

With rotary asynchronous motors the motor encoder can be mounted load side.

## Absolute Encoder Evaluation and Monitoring of 2 Absolute Measuring Systems

The use of a second absolute encoder buffer is now possible. Two absolute measuring systems can be operated without restrictions. A plausibility check of the absolute encoder data is also possible so that an exchange of encoders always clears the home of the encoder.

## Expanded E-Stop Input Function

The reaction of the drive to a signal at the E-stop input was expanded. With bit 2 of parameter **P-0-0008, Activation E-Stop function** it can be selected, with E-stop function activated, whether the drive responds with an error reaction or the reaction should be a fatal warning.

If the definition of "Fatal warning" has been parametrized, the drive responds as with the removal of the external drive enable with the response parametrized in **P-0-0119, Best possible deceleration**. The warning diagnosis **E834 Emergency-Stop** appears.

The state of the E-stop input can be checked via parameter **P-0-0223, Status Input E-Stop function**. The state of this input is stored in bit 0.

## Configuration Power Shutdown with Fault and Undervoltage

The reaction options with power shutdown with fault and with DC bus undervoltage were expanded. The following options are now available.

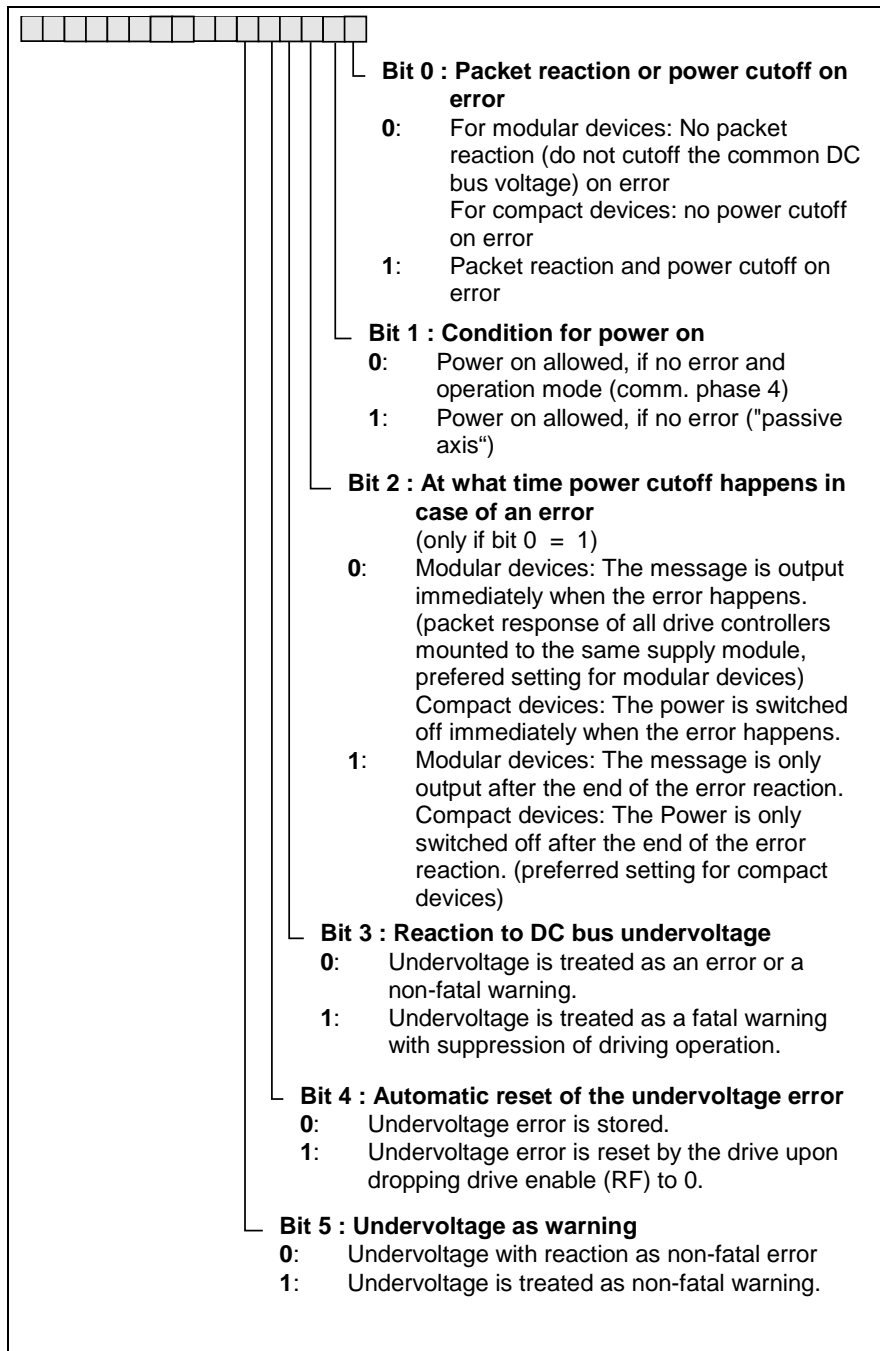

Fig. 2-3: P-0-0118, Power off on error

# Controller Structure

The following controller structure has been implemented in SHS03VRS:

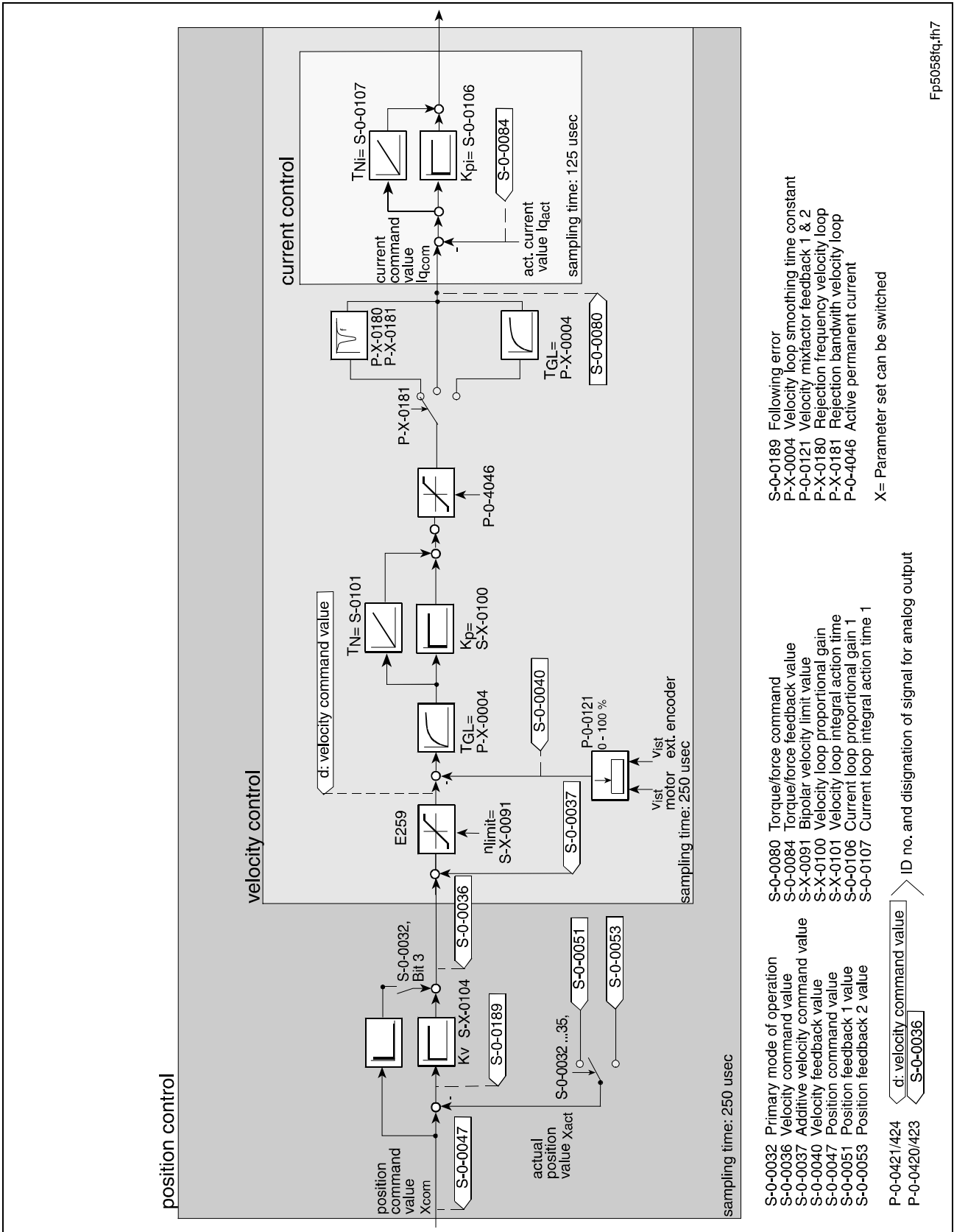

Fig. 2-4: Controller structure

Fp5058fq.fh7

## Velocity Control Loop

The actual velocity filter ( **S-0-0392, Velocity feedback filter** ) is gone. The velocity control loop deviation can be filtered with a PT1 filter. Use parameter **P-X-0004, Velocity loop smoothing time constant** to parametrize.

The lock filter can also be used as a second PT1 filter. Use **P-X-0181, Rejection bandwidth velocity loop** = -1 to do this. The time constant of the filter is fixed in parameter **P-X-0004, Velocity loop smoothing time constant**. This implements a PT2 filter in the velocity control loop (see **Controller structure**).

## Drive Halt

Drive halt evokes various responses depending on the operating mode:

- with interpolation it is brought to a standstill with the last active accel and jerk in position control
- with other position control modes, standstill uses **S-0-0138, Bipolar acceleration limit value** and **S-0-0349, Jerk limit bipolar** .
- with other operating modes, e.g., velocity and torque control, standstill in velocity control takes torque command value ramps and filters into account.

## Drive-Controlled Homing

Drive-controlled homing is no longer functionally like spindle positioning. The travel profile can be defined independently just like the end point after homing. Use the following parameters to do this:

- **S-0-0147, Homing parameter**
- **S-0-0041, Homing velocity**
- **S-0-0042, Homing acceleration**
- **S-0-0349, Jerk limit bipolar**

In the homing parameter it is also set whether a motor encoder, spindle encoder or a switched are homed to.

Drive-controlled homing is automatically triggered if spindle positioning is started and the drive has not yet been homed. After home has been determined, the spindle angle position is immediately travelled to without going to home first or having the drive stop.

## Homing Absolute Measuring Systems with Positioning to Home

By setting bit 7 in parameter **S-0-0147, Homing parameter** and starting command **S-0-0148, C600 Drive controlled homing procedure command** the drive positions at home. This is also now possible with absolute measuring systems if the relevant system has been homed.

## Expanding Parameter S-0-0403, Position feedback value status

Two new bits have been defined in parameter **S-0-0403, Position feedback value status**.

Expanded structure of parameter:

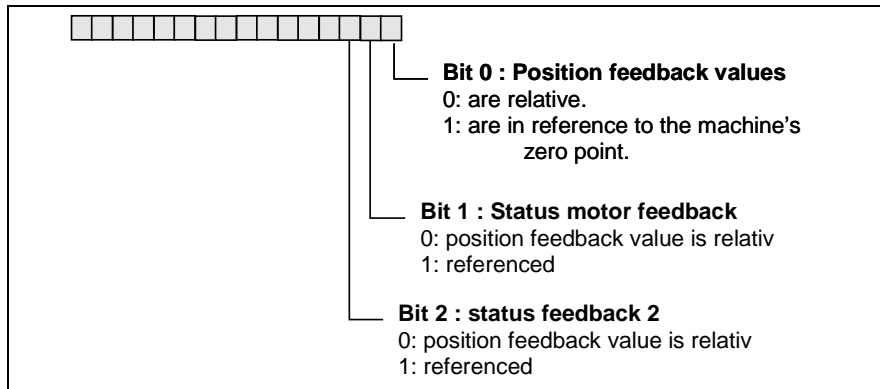

Fig. 2-5: S-0-0403, Status of actual position values

## Configurable Signal Status Word

The definition of the individual bits is specified in the signal status word.

The configurable signal status word serves to accept a maximum of 16 copies of bits that are in other drive parameters. This means that the user can **compile a bit list** that contains all the **status information** of the drive that is important to the control.

The following parameters are used for this function:

- **S-0-0144, Signal status word**  
configurable bit strip
- **S-0-0026, Configuration list signal status word**  
ID number list with variable length to configure the bit strip
- **S-0-0328, Assign list signal status word**  
bit number list with variable length to configure the bit strip

The load base parameters command sets the configuration of the signal status word so that it is compatible to SHS02VRS.

## Analog Output

The present analog output was replaced with the universal analog output with parameters **P-0-0420, Analog output 1 signal selection** to **P-0-0426, Analog outputs, IDN list of assignable parameters**.

## Analog Inputs

The analog inputs in this firmware are deactivated!

## Digital I/Os

The plug-in modules for the digital I/O of signals have been reduced. The firmware now only supports the DEA 4 and 8 modules. The allocation of parameters to digital I/Os is no longer possible.

## Command Spindle Positioning

The command to position the spindle has been altered as follows:

- The choice of positioning procedure (motor or optional encoder, cam switch) is defined in parameter **S-0-0147, Homing parameter**.
- To compute the effective modulo value for spindle positioning use **S-0-0103, Modulo value** and **S-0-0294, Divider for modulo value**.
- Positioning takes the values in **S-X-0138 bipolar accel** and **S-0-0349, Jerk limit bipolar** into account.
- To search for homing signals run with **S-0-0041, Homing velocity**.

## Gear Switching

If different gear ratios have been programmed in various program blocks, then the display value of the actual position value jumps whenever a parameter block is switched.

## Communication via Serial Interface Phased-Out

Communications between drive and „control“ via serial interface is no longer supported.



## 2.5 New Parameters

- S-0-0018, IDN list of operation data for CP2
- S-0-0019, IDN list of operation data for CP3
- S-0-0025, IDN list of all procedure commands
- S-0-0026, Configuration list signal status word
- S-0-0037, Additive velocity command value
- S-0-0041, Homing velocity
- S-0-0042, Homing acceleration
- S-0-0125, Velocity threshold nx
- S-0-0139, D700 Command Parking axis
- S-0-0165, Distance coded reference offset 1
- S-0-0166, Distance coded reference offset 2
- S-0-0173, Marker position A
- S-0-0191, D600 Cancel reference point procedure command
- S-0-0256, Multiplication 1
- S-0-0257, Multiplication 2
- S-0-0272, Velocity window as percentage
- S-0-0278, Maximum travel range
- S-0-0292, List of all operating modes
- S-0-0294, Divider for modulo value
- S-0-0328, Assign list signal status word
- S-0-0332, Message 'nactual < nx'
- S-0-0359, Drive internal interpolation mode
- S-0-0360, MDT Data container A
- S-0-0364, AT Data container A
- S-0-0368, Addressing for data container A
- S-0-0370, Configuration list for MDT data container
- S-0-0371, Configuration list for the AT data container
- S-0-0375, List of diagnostic numbers
- S-0-0378, Encoder 1, absolute range
- S-0-0379, Encoder 2, absolute range
- S-1-0272, Velocity window as percentage
- S-2-0272, Velocity window as percentage
- S-3-0272, Velocity window as percentage
- S-7-0100, Velocity loop proportional gain
- S-7-0101, Velocity loop integral action time
- S-7-0104, Position loop Kv-factor
- S-7-0106, Current loop proportional gain 1
- S-7-0107, Current loop integral action time 1
- S-7-0117, Feedback 2 Resolution
- S-7-0177, Absolute distance 1
- S-7-0178, Absolute distance 2
- P-0-0004, Velocity loop smoothing time constant

- P-1-0004, Velocity loop smoothing time constant
- P-2-0004, Velocity loop smoothing time constant
- P-3-0004, Velocity loop smoothing time constant
- P-0-0014, D500 Command determine marker position
- P-0-0139, Analog output 1
- P-0-0140, Analog output 2
- P-0-0170, Parallel I/O output 4
- P-0-0171, Parallel I/O input 4
- P-0-0176, Torque/Force command smoothing time constant
- P-1-0176, Torque/Force command smoothing time constant
- P-2-0176, Torque/Force command smoothing time constant
- P-3-0176, Torque/Force command smoothing time constant
- P-0-0177, Absolute encoder buffer 1
- P-0-0178, Absolute encoder buffer 2
- P-0-0185, Function of encoder 2
- P-0-0187, Position command processing mode
- P-0-0190, Operating hours control section
- P-0-0191, Operating hours power section
- P-0-0192, Error recorder, diagnosis number
- P-0-0193, Error recorder, operating hours control section
- P-0-0194, List of present plug-in modules
- P-0-0223, Status Input E-Stop function
- P-0-0247, Version of safety functions
- P-0-0248, Checksum over scaled data, drive
- P-0-0249, Activation of the safety functions
- P-0-0250, Safety input signals of the drive
- P-0-0251, Safety output signals of the drive
- P-0-0252, State of safety function, drive
- P-0-0253, Max. speed 1 for safety function, drive
- P-0-0254, Upper position limit 1 for safety function, drive
- P-0-0255, Lower position limit 1 for safety function, drive
- P-0-0256, Max. speed 2 for safety function, drive
- P-0-0257, Upper position limit 2 for safety function, drive
- P-0-0258, Lower position limit 2 for safety function, drive
- P-0-0259, Upper position limit for position switch 1, drive
- P-0-0260, Lower position limit for position switch 1, drive
- P-0-0261, Upper position limit for position switch 2, drive
- P-0-0262, Lower position limit for position switch 2, drive
- P-0-0263, Upper position limit for position switch 3, drive
- P-0-0264, Lower position limit for position switch 3, drive
- P-0-0265, Upper position limit for position switch 4, drive
- P-0-0266, Lower position limit for position switch 4, drive
- P-0-0267, Pos. monitoring window for safe stop operation, drive
- P-0-0268, Reference position for safe homing, drive
- P-0-0269, Mask of unused safety inputs, drive

- P-0-0270, Changeover time for safety function, drive
- P-0-0271, Time interval for forced dynamization, drive
- P-0-0272, C000 Command Check reference
- P-0-0273, Monitored actual position, drive
- P-0-0274, Preset forced dynamization
- P-0-0275, Acknowledge forced dynamization
- P-0-0276, State of safety function, control
- P-0-0277, Max. speed 1 for safety function, control
- P-0-0278, Upper position limit 1 for safety function, control
- P-0-0279, Lower position limit 1 for safety function, control
- P-0-0280, Max. speed 2 for safety function, control
- P-0-0281, Upper position limit 2 for safety function, control
- P-0-0282, Lower position limit 2 for safety function, control
- P-0-0283, Upper position limit for position switch 1, control
- P-0-0284, Lower position limit for position switch 1, control
- P-0-0285, Upper position limit for position switch 2, control
- P-0-0286, Lower position limit for position switch 2, control
- P-0-0287, Upper position limit for position switch 3, control
- P-0-0288, Lower position limit for position switch 3, control
- P-0-0289, Upper position limit for position switch 4, control
- P-0-0290, Lower position limit for position switch 4, control
- P-0-0291, Pos. monitoring window for safe stop operation, control
- P-0-0292, Reference position for safe homing, control
- P-0-0293, Mask of unused safety inputs, control
- P-0-0294, Changeover time for safety function, control
- P-0-0295, Time interval for forced dynamization, control
- P-0-0296, Monitored actual position, control
- P-0-0297, Checksum over scaled data, control
- P-0-0420, Analog output 1 signal selection
- P-0-0421, Analog output 1, expanded signal selection
- P-0-0422, Analog output 1, scaling per 10V full scale
- P-0-0423, Analog output 2, signal selection
- P-0-0424, Analog output 2, expanded signal selection
- P-0-0425, Analog output 2, scaling per 10V full scale
- P-0-0426, Analog outputs, IDN list of assignable parameters
- P-0-0542, B100 Command Open motor holding brake
- P-0-0560, Commutation adjustment current
- P-0-0562, Commutation adjustment periodic time
- P-0-0563, Reluctance value
- P-0-0640, Cooling type
- P-0-4047, Motor inductance
- P-0-4094, C800 Command Base-parameter load
- P-7-0004, Velocity loop smoothing time constant
- P-7-0517, Feedback type 2
- P-7-4014, Motor type

## 2.6 Expanded/Altered Parameters

- S-0-0013, Class 3 diagnostics
- S-0-0032, Primary mode of operation
- S-0-0033, Secondary operation mode 1
- S-0-0034, Secondary operation mode 2
- S-0-0035, Secondary operation mode 3
- S-0-0040, Velocity feedback value
- S-0-0144, Signal status word
- S-0-0154, Spindle position parameter
- S-0-0182, Manufacturer class 3 diagnostics
- S-0-0403, Position feedback value status
- P-0-0008, Activation E-Stop function
- P-0-0018, Number of pole pairs/pole pair distance
- P-0-0074, Feedback 1 type
- P-0-0075, Feedback 2 type
- P-0-0118, Power off on error
- P-0-0181, Rejection bandwidth velocity loop
- P-0-0525, Type of motor brake
- P-0-0538, Motor function parameter 1
- P-0-4014, Motor type

## 2.7 Deleted Parameters

- S-0-0077, Linear position data scaling factor
- S-0-0078, Linear position data scaling exponent
- S-0-0130, Probe value 1 positive edge
- S-0-0131, Probe value 1 negative edge
- S-0-0132, Probe value 2 positive edge
- S-0-0133, Probe value 2 negative edge
- S-0-0169, Probe control parameter
- S-0-0170, Probing cycle procedure command
- S-0-0392, Velocity feedback filter
- S-0-0401, Probe 1
- S-0-0402, Probe 2
- S-0-0405, Probe 1 enable
- S-0-0406, Probe 2 enable
- S-0-0409, Probe 1 positive latched
- S-0-0410, Probe 1 negative latched
- S-0-0411, Probe 2 positive latched
- S-0-0412, Probe 2 negative latched
- P-0-0038, Signal select analog output channel 1
- P-0-0038, Signal select analog output channel 1
- P-0-0040, Scaling factor for velocity data channel 1
- P-0-0041, Scaling factor for velocity data channel 2

- P-0-0042, Scaling factor for position data channel 1
- P-0-0043, Scaling factor for position data channel 2
- P-0-0044, Scaling factor for power analog outputs
- P-0-0110, Parallel I/O output 2
- P-0-0111, Parallel I/O input 2
- P-0-0112, Parallel I/O output 3
- P-0-0113, Parallel I/O input 3
- P-0-0115, Analog input 1
- P-0-0116, Analog input 2
- P-0-0123, Absolute encoder buffer
- P-0-0124, Assignment IDN -> DEA-output
- P-0-0125, Assignment DEA-input -> IDN
- P-0-0200, Signal select probe 1
- P-0-0201, Signal select probe 2
- P-0-0202, Difference probe values 1
- P-0-0203, Difference probe values 2
- P-0-0300, Spindle position parameter 2
- P-0-0310, Analog torque-command per 10V
- P-0-0311, Analog velocity-command per 10V
- P-0-0514, Absolute encoder offset
- P-0-1215, Cam search speed
- P-0-4023, C400 Communication phase 2 transition
- P-0-4036, Contacted motor type
- P-7-0512, Default value for Kv-factor of position control
- P-7-0514, Absolute encoder offset
- P-7-4037, Velocity loop prop. gain, default
- P-7-4038, Velocity loop integral action time, default
- P-7-4039, Current loop prop. gain, default
- P-7-4042, Speed control smoothing time, default
- P-7-4049, Current loop integral action time, default

## 2.8 New Diagnoses

- B100 Command release motor brake
- B101 Command not enabled
- C000 Command Check reference
- C001 Safe reference not possible
- C117 Timeout at command execution
- C118 Order of MDT configuration wrong
- C606 Reference mark not detected
- C800 Default parameter load
- D311 Commutation offset could not be determined.
- D312 Motion range exceeded during commutation
- D500 Command Get mark position
- D501 Incremental encoder required

- D600 Cancel reference point procedure command
- D700 Parking axis command
- E225 Motor overload
- E226 Undervoltage in power section
- E264 Target position out of num. range
- E408 Invalid addressing of MDT-data container A
- E409 Invalid addressing of AT-data container A
- E826 Undervoltage in power section
- F228 Excessive deviation
- F270 Error power supply home switch
- F271 Error power supply travel limit switch
- F272 Error power supply probe input
- F273 Error power supply E-Stop
- F277 Current measurement trim wrong
- F434 Emergency-Stop
- F501 Monitoring Safe Halt
- F502 Monitoring Safe operating halt
- F503 Monitoring safely reduced speed 1 + abs. pos. 1
- F504 Monitoring safely reduced speed 2 + abs. pos. 2
- F505 Activation of a safety function wrong
- F506 Forced dynamization necessary
- F507 Safety input signals wrong, checksum
- F508 Safety input signals wrong, counter
- F509 Data crosscheck wrong
- F510 Safe reference lost
- F511 Monitoring of safely reduced speed during switchover
- F634 Emergency-Stop
- F811 Commutation offset could not be determined.
- F812 Motion range exceeded during commutation

## 2.9 Diagnoses Removed

- C209 Device and software are incompatible
- C701 Basic load not possible if drive is enabled
- C901 Error during position spindle command
- C903 Error during initialization
- C904 Encoder 2 not present
- E829 Positive position limit exceeded
- E830 Negative position limit exceeded
- E843 Positive limit switch activated
- E844 Negative limit switch activated

### 3 Kundenbetreuungsstellen - Sales & Service Facilities

#### Deutschland – Germany

**vom Ausland:** (0) nach Landeskennziffer weglassen!!  
**from abroad:** don't dial (0) after country code!

Vertriebsgebiet Mitte <input checked="" type="checkbox"/> SALES Germany Centre <input checked="" type="checkbox"/> Service REXROTH INDRAMAT GmbH Bgm.-Dr.-Nebel-Str. 2 D - 97816 Lohr am Main Telefon: +49 (0)9352/40-0 Telefax: +49 (0)9352/40-4885	Vertriebsgebiet Ost <input checked="" type="checkbox"/> SALES Germany East <input checked="" type="checkbox"/> Service REXROTH INDRAMAT GmbH Beckerstraße 31 D - 09120 Chemnitz Telefon: +49 (0)371/35 55-0 Telefax: +49 (0)371/35 55-333	Vertriebsgebiet West <input checked="" type="checkbox"/> SALES Germany West <input checked="" type="checkbox"/> Service Mannesmann Rexroth AG Vertrieb Deutschland Regionalzentrum West Borsigstrasse 15 D - 40880 Ratingen Telefon: +49 (0)2102/409-0 Telefax: +49 (0)2102/409-406	Vertriebsgebiet Nord <input checked="" type="checkbox"/> SALES Germany North <input type="checkbox"/> Service REXROTH INDRAMAT GmbH Kieler Straße 212 D - 22525 Hamburg Telefon: +49 (0)40/85 31 57-0 Telefax: +49 (0)40/85 31 57-15
Vertriebsgebiet Süd <input checked="" type="checkbox"/> SALES Germany South <input type="checkbox"/> Service REXROTH INDRAMAT GmbH Ridlerstraße 75 D - 80339 München Telefon: +49 (0)89/540138-30 Telefax: +49 (0)89/540138-10 indramat.mue@t-online.de	Gebiet Südwest <input checked="" type="checkbox"/> SALES Germany South-West <input checked="" type="checkbox"/> Service Mannesmann Rexroth AG Vertrieb Deutschland – VD-BI Geschäftsbereich Rexroth Indramat Regionalzentrum Südwest Ringstrasse 70 / Postfach 1144 70736 Fellbach / 70701 Fellbach Tel.: +49 (0)711/57 61-100 Fax: +49 (0)711/57 61-125	Vertriebsgebiet Mitte <input checked="" type="checkbox"/> SALES Germany Centre <input type="checkbox"/> Service Mannesmann Rexroth AG Gesch.ber. REXROTH INDRAMAT Lilistraße 14-18 D - 63067 Offenbach Telefon: +49 (0) 69/82 00 90-0 Telefax: +49 (0) 69/82 00 90-80	Vertriebsgebiet Nord <input checked="" type="checkbox"/> SALES Germany North <input type="checkbox"/> Service Mannesmann Rexroth AG Vertriebsniederlassung Region Nord Gesch.ber. REXROTH INDRAMAT Walsroder Str. 93 D - 30853 Langenhagen Telefon: +49 (0) 511/72 66 57-0 Telefax: +49 (0) 511/72 66 57-93
		SERVICE - Hotline - 7 Tage / 24h - <b>HEL P DESK</b> <b>MO – FR - von 7 – 17 Uhr</b> Telefax +49 (0)9352/40-4941 Telefon +49 (0)9352/40- Bernard A. -4894 Kolb R. -4922 Pfeffermann O. -4808 Roeper P. -4359 Scheiner W. -4921 <b>AUSSERHALB dieser Zeit:</b> Telefon: +49 (0)172/660 04 06 oder/or Telefon: +49 (0)171/333 88 26	ERSATZTEIL - Hotline ♦ nur an Werktagen ♦ von 15 -18 Uhr <b>Tel. +49 (0) 93 52/40 42 22</b>

Kundenbetreuungsstellen in Deutschland - Service agencies in Germany

## Europa – Europe

vom Ausland: (0) nach Landeskennziffer weglassen, 0 nach Landeskennziffer mitwählen!  
from abroad: don't dial (0) after country code, dial 0 after country code!

<p>Austria <input checked="" type="checkbox"/> SALES <input type="checkbox"/> Service</p> <p>Mannesmann Rexroth Ges.m.b.H. Gesch.ber. REXROTH INDRAMAT Hägelingasse 3 A - 1140 Wien</p> <p>Telefon: +43 (0)1/9852540-400 Telefax: +43 (0)1/9852540-93</p>	<p>Austria <input checked="" type="checkbox"/> SALES <input type="checkbox"/> Service</p> <p>Mannesmann Rexroth G.m.b.H. Gesch.ber. REXROTH INDRAMAT Industriepark 18 A - 4061 Pasching</p> <p>Telefon: +43 (0)7221/605-0 Telefax: +43 (0)7221/605-21</p>	<p>Belgium <input checked="" type="checkbox"/> SALES <input checked="" type="checkbox"/> Service</p> <p>Mannesmann Rexroth N.V.-S.A. Gesch.ber. REXROTH INDRAMAT Industrielaan 8 B-1740 Ternat</p> <p>Telefon: +32 (0)2/5830719 Telefax: +32 (0)2/5830731</p>	<p>Denmark <input checked="" type="checkbox"/> SALES <input checked="" type="checkbox"/> Service</p> <p>BEC AS Zinkvej 6 DK-8900 Randers</p> <p>Telefon: +45 (0)87/11 90 60 Telefax: +45 (0)87/11 90 61</p>
<p>England <input checked="" type="checkbox"/> SALES <input checked="" type="checkbox"/> Service</p> <p>Mannesmann Rexroth Ltd. REXROTH INDRAMAT Division Broadway Lane, South Cerney GB - Cirencester, Glos GL7 5UH</p> <p>Telefon: +44 (0)1285/863000 Telefax: +44 (0)1285/863030</p>	<p>Finland <input checked="" type="checkbox"/> SALES <input type="checkbox"/> Service</p> <p>Rexroth Mecman Oy REXROTH INDRAMAT division Ansatie 6 SF-017 40 Vantaa</p> <p>Telefon: +358 (0)9/84 91-11 Telefax: +358 (0)9/84 91-13 60</p>	<p>France <input checked="" type="checkbox"/> SALES <input checked="" type="checkbox"/> Service</p> <p>Mannesmann Rexroth S.A. Division REXROTH INDRAMAT Parc des Barbanniers 4, Place du Village F-92632 Gennevilliers Cedex</p> <p>Telefon: +33 (0)141 47 54 30 Telefax: +33 (0)147 94 69 41 Hotline: +33 (0)6 08 33 43 28</p>	<p>France <input checked="" type="checkbox"/> SALES <input type="checkbox"/> Service</p> <p>Mannesmann Rexroth S.A. Division REXROTH INDRAMAT 270, Avenue de Lardenne F - 31100 Toulouse</p> <p>Telefon: +33 (0)5 61 49 95 19 Telefax: +33 (0)5 61 31 00 41</p>
<p>France <input checked="" type="checkbox"/> SALES <input type="checkbox"/> Service</p> <p>Mannesmann Rexroth S.A. Division REXROTH INDRAMAT 91, Bd. Irène Joliot-Curie F - 69634 Vénissieux – Cedex</p> <p>Telefon: +33 (0)4 78 78 53 65 Telefax: +33 (0)4 78 78 53 62</p>	<p>Italy <input checked="" type="checkbox"/> SALES <input checked="" type="checkbox"/> Service</p> <p>Mannesmann Rexroth S.p.A. Divisione REXROTH INDRAMAT Via G. Di Vittoria, 1 I - 20063 Cernusco S/N.MI</p> <p>Telefon: +39 02/92 36 52 70 Telefax: +39 02/92 36 55 12</p>	<p>Italy <input checked="" type="checkbox"/> SALES <input checked="" type="checkbox"/> Service</p> <p>Mannesmann Rexroth S.p.A. Divisione REXROTH INDRAMAT Via Borgomanero, 11 I - 10145 Torino</p> <p>Telefon: +39 011/7 50 38 11 Telefax: +39 011/7 71 01 90</p>	<p>Italy <input checked="" type="checkbox"/> SALES <input type="checkbox"/> Service</p> <p>Mannesmann Rexroth S.p.A. Divisione REXROTH INDRAMAT Via del Progresso, 16 (Zona Ind.) I - 35020 Padova</p> <p>Telefon: +39 049/8 70 13 70 Telefax: +39 049/8 70 13 77</p>
<p>Italy <input type="checkbox"/> SALES <input checked="" type="checkbox"/> Service</p> <p>Mannesmann Rexroth S.p.A. Divisione Rexroth Indramat Via Mascia, 1 I - 80053 Castellammare di Stabia NA</p> <p>Telefon: +39 081/8 71 57 00 Telefax: +39 081/8 71 68 86</p>	<p>Italy <input checked="" type="checkbox"/> SALES <input type="checkbox"/> Service</p> <p>Mannesmann Rexroth S.p.A. Divisione REXROTH INDRAMAT Viale Oriani, 38/A I - 40137 Bologna</p> <p>Telefon: +39 051/34 14 14 Telefax: +39 051/34 14 22</p>	<p>Netherlands <input checked="" type="checkbox"/> SALES <input type="checkbox"/> Service</p> <p>Hydraudyne Hydrauliek B.V. Kruisbroeksestraat 1 (P.O. Box 32) NL - 5281 RV Boxtel</p> <p>Telefon: +31 (0)411/65 19 51 Telefax: +31 (0)411/65 14 83 e-mail: indramat@hydraudyne.nl</p>	<p>Netherlands <input type="checkbox"/> SALES <input checked="" type="checkbox"/> Service</p> <p>Hydrocare B.V. Kruisbroeksestraat 1 (P.O. Box 32) NL - 5281 RV Boxtel</p> <p>Telefon: +31 (0)411/65 19 51 Telefax: +31 (0)411/67 78 14</p>
<p>Norway <input checked="" type="checkbox"/> SALES <input type="checkbox"/> Service</p> <p>Rexroth Mecman AS REXROTH INDRAMAT Division Berghagan 1 or: Box 3007 N -1405 Ski-Langhus N -1402 Ski</p> <p>Telefon: +47 (0)64 86 41 00 Telefax: +47 (0)64 86 90 62</p>	<p>Poland <input checked="" type="checkbox"/> SALES <input type="checkbox"/> Service</p> <p>Mannesmann Rexroth Sp.zo.o. Biuro Poznan ul. Dabrowskiego 81/85 PL - 60-529 Poznan</p> <p>Telefon: +48 061/847 67 99 Telefax: +48 061/847 64 02</p>	<p>Russia <input type="checkbox"/> SALES <input checked="" type="checkbox"/> Service</p> <p>Tschudnenko E.B. Arsenia 22 RUS - 153000 Ivanovo Rußland</p> <p>Telefon: +7 093/223 96 33 oder/or +7 093/223 95 48 Telefax: +7 093/223 46 01</p>	<p>Spain <input checked="" type="checkbox"/> SALES <input checked="" type="checkbox"/> Service</p> <p>Mannesmann Rexroth S.A. Division REXROTH INDRAMAT Centro Industrial Santiga Obradors s/n E-08130 Santa Perpetua de Mogoda Barcelona</p> <p>Telefon: +34 937 47 94 00 Telefax: +34 937 47 94 01</p>
<p>Spain <input checked="" type="checkbox"/> SALES <input checked="" type="checkbox"/> Service</p> <p>Goimendi S.A. División REXROTH INDRAMAT Jolastokieta (Herrera) Apartado 11 37 E - 20017 San Sebastian</p> <p>Telefon: +34 9 43/40 01 63 Telefax: +34 9 43/39 17 99</p>	<p>Sweden <input checked="" type="checkbox"/> SALES <input checked="" type="checkbox"/> Service</p> <p>Rexroth Mecman Svenska AB REXROTH INDRAMAT Division Varuvägen 7 S - 125 81 Stockholm</p> <p>Telefon: +46 (0)8/727 92 00 Telefax: +46 (0)8/647 32 77</p>	<p>Slowenia <input checked="" type="checkbox"/> SALES <input checked="" type="checkbox"/> Service</p> <p>REXROTH INDRAMAT elektromotorji d.o.o. Otoki 21 SLO - 64 228 Zelezniki</p> <p>Telefon: +386 64/61 73 32 Telefax: +386 64/64 71 50</p>	<p>Turkey <input checked="" type="checkbox"/> SALES <input checked="" type="checkbox"/> Service</p> <p>Mannesmann Rexroth Hidropar A..S. Fevzi Cakmak Cad No. 3 TR - 34630 Sefaköy Istanbul</p> <p>Telefon: +90 212/541 60 70 Telefax: +90 212/599 34 07</p>
<p>Switzerland <input checked="" type="checkbox"/> SALES <input checked="" type="checkbox"/> Service</p> <p>-East-</p> <p>Mannesmann Rexroth Schweiz AG Gesch.ber. REXROTH INDRAMAT Gewerbstraße 3 CH - 8500 Frauenfeld</p> <p>Telefon: +41 (0)52/720 21 00 Telefax: +41 (0)52/720 21 11</p>	<p>Switzerland <input checked="" type="checkbox"/> SALES <input type="checkbox"/> Service</p> <p>-West-</p> <p>Mannesmann Rexroth Suisse SA Département REXROTH INDRAMAT Rue du village 1 CH - 1020 Renens</p> <p>Telefon: +41 (0)21/632 84 20 Telefax: +41 (0)21/632 84 21</p>		

Europäische Kundenbetreuungsstellen (ohne Deutschland)

European Service agencies (without Germany)



## Außerhalb Europa - outside Europe

vom Ausland:

(0) nach Landeskennziffer weglassen!

from abroad:

don't dial (0) after country code!

<p>Argentina <input checked="" type="checkbox"/> SALES <input type="checkbox"/> Service</p> <p>Mannesmann Rexroth S.A.I.C. Division REXROTH INDRAMAT Acassusso 48 41/7 RA - 1605 Munro (Buenos Aires)</p> <p>Telefon: +54 (0)11/4756 01 40 Telefax: +54 (0)11/4762 6862 e-mail:mannesmann@impsat1.com.ar</p>	<p>Argentina <input checked="" type="checkbox"/> SALES <input checked="" type="checkbox"/> Service</p> <p>NAKASE Servicio Tecnico CNC Calle 49, No. 5764/66 RA - 1653 Villa Balester Prov. - Buenos Aires</p> <p>Telefon: +54 (0) 11/4768 36 43 Telefax: +54 (0) 11/4768 24 13 e-mail: nakase@usa.net nakase@infovia.com.ar</p>	<p>Australia <input checked="" type="checkbox"/> SALES <input checked="" type="checkbox"/> Service</p> <p>AIMS - Australian Industrial Machinery Services Pty. Ltd. Unit 3/45 Horne ST Campbellfield , VIC 3061 AUS - Melbourne</p> <p>Telefon: +61 (0)3/93 59 02 28 Telefax: +61 (0)3/93 59 02 86</p>	<p>Australia <input checked="" type="checkbox"/> SALES <input type="checkbox"/> Service</p> <p>Mannesmann Rexroth Pty. Ltd. No. 7, Endeavour Way Braeside Victoria, 31 95 AUS - Melbourne</p> <p>Telefon: +61 (0)3/95 80 39 33 Telefax: +61 (0)3/95 80 17 33 Email: mel@rexroth.com.au</p>
<p>Brazil <input checked="" type="checkbox"/> SALES <input checked="" type="checkbox"/> Service</p> <p>Mannesmann Rexroth Automação Ltda. Divisão REXROTH INDRAMAT Rua Georg Rexroth, 609 Vila Padre Anchieta BR - 09951-270 Diadema-SP [ Caixa Postal 377 ] [ BR-09901-970 Diadema-SP ]</p> <p>Telefon: +55 (0)11/745 90 60 +55 (0)11/745 90 70 Telefax: +55 (0)11/745 90 50 e-mail: awittwer@rexroth.com.br</p>	<p>Brazil <input type="checkbox"/> SALES <input checked="" type="checkbox"/> Service</p> <p>Mannesmann Rexroth Automação Ltda. Divisão REXROTH INDRAMAT R. Dr.Humberto Pinheiro Vieira, 100 Distrito Industrial BR - 89220-390 Joinville - SC [ Caixa Postal 1273 ]</p> <p>Tel./Fax: +55 (0)47/473 58 33 Mobil: +55 (0)47 974 66 45 e-mail: prochnow@zaz.com.br</p>	<p>Canada <input checked="" type="checkbox"/> SALES <input checked="" type="checkbox"/> Service</p> <p>Basic Technologies Corporation Burlington Division 3426 Mainway Drive Burlington, Ontario Canada L7M 1A8</p> <p>Telefon: +1 905/335 55 11 Telefax: +1 905/335-41 84</p>	<p>China <input type="checkbox"/> SALES <input checked="" type="checkbox"/> Service</p> <p>Mannesmann Rexroth (China) Ltd. Shanghai Parts &amp; Service Center 199 Wu Cao Road, Hua Cao Minhang District PRC - Shanghai 201 103</p> <p>Telefon: +86 21/62 20 00 58 Telefax: +86 21/62 20 00 68</p>
<p>China <input checked="" type="checkbox"/> SALES <input type="checkbox"/> Service</p> <p>Mannesmann Rexroth (China) Ltd. 15/F China World Trade Center 1, Jianguomenwai Avenue PRC - Beijing 100004</p> <p>Telefon: +86 10/65 05 03 80 Telefax: +86 10/65 05 03 79</p>	<p>China <input checked="" type="checkbox"/> SALES <input type="checkbox"/> Service</p> <p>Mannesmann Rexroth (China) Ltd. A-5F., 123 Lian Shan Street Sha He Kou District PRC - Dalian 116 023</p> <p>Telefon: +86 411/46 78 930 Telefax: +86 411/46 78 932</p>	<p>Hongkong <input checked="" type="checkbox"/> SALES <input checked="" type="checkbox"/> Service</p> <p>Rexroth (China) Ltd. 1/F., 19 Cheung Shun Street Cheung Sha Wan, Kowloon, Hongkong</p> <p>Telefon: +852 22 62 51 00 Telefax: +852 27 44 02 78</p>	<p>India <input checked="" type="checkbox"/> SALES <input checked="" type="checkbox"/> Service</p> <p>Mannesmann Rexroth (India) Ltd. REXROTH INDRAMAT Division Plot. 96, Phase III Peenya Industrial Area IND - Bangalore - 560058</p> <p>Telefon: +91 (0)80/8 39 73 74 Telefax: +91 (0)80/8 39 43 45</p>
<p>India <input checked="" type="checkbox"/> SALES <input checked="" type="checkbox"/> Service</p> <p>Mannesmann Rexroth (India) Ltd. REXROTH INDRAMAT Division Plot. A-58, TTC Industrial Area Thane Turbhe Midc Road Mahape Village IND - Navi Mumbai - 400 701</p> <p>Telefon: +91 (0)22/7 61 46 22 Telefax: +91 (0)22/7 68 15 31</p>	<p>Indonesia <input checked="" type="checkbox"/> SALES <input type="checkbox"/> Service</p> <p>PT. Rexroth Wijayakusuma Jl. Raya Bekasi Km 21 Pulogadung RI - Jakarta Timur 13920</p> <p>Telefon: +62 21/4 61 04 87 +62 21/4 61 04 88 Telefax: +62 21/4 60 01 52</p>	<p>Japan <input type="checkbox"/> SALES <input checked="" type="checkbox"/> Service</p> <p>Rexroth Automation Co., Ltd. Service Center Japan Yutakagaoka 1810, Meito-ku, NAGOYA 465-0035, Japan</p> <p>Telefon: +81 (0)52/777 88 41 +81 (0)52/777 88 53 +81 (0)52/777 88 79 Telefax: +81 (0)52/777 89 01</p>	<p>Japan <input checked="" type="checkbox"/> SALES <input checked="" type="checkbox"/> Service</p> <p>Rexroth Automation Co., Ltd. REXROTH INDRAMAT Division 1F, I.R. Building Nakamachidai 4-26-44, Tsuzuki-ku YOKOHAMA 224-0041, Japan</p> <p>Telefon: +81 (0)45/942 72 10 Telefax: +81 (0)45/942 03 41</p>
<p>Mexico <input checked="" type="checkbox"/> SALES <input type="checkbox"/> Service</p> <p>Mannesmann Rexroth Mexico S.A. de C.V. Calle Neptuno 72 Unidad Ind. Vallejo MEX - 07700 Mexico, D.F.</p> <p>Telefon: +52 5 754 17 11 +52 5 754 36 84 +52 5 754 12 60 Telefax: +52 5 754 50 73 +52 5 752 59 43 e-mail: gсорia@rexroth-mexico.com</p>	<p>Korea <input checked="" type="checkbox"/> SALES <input checked="" type="checkbox"/> Service</p> <p>Mannesmann Rexroth-Seki Co Ltd. 1500-12 Da-Dae-Dong ROK - Saha-Ku, Pusan, 604-050</p> <p>Telefon: +82 (0)51/2 60 06 18 Telefax: +82 (0)51/2 60 06 19</p>	<p>Korea <input checked="" type="checkbox"/> SALES <input checked="" type="checkbox"/> Service</p> <p>Seo Chang Corporation Ltd. Room 903, Jail Building 44-35 Yeuido-Dong Yeoungdeungpo-Ku C.P.O.Box 97 56 ROK - Seoul</p> <p>Telefon: +82 (0)2/7 80 82 08 +82 (0)2/7 80 82 09 Telefax: +82 (0)2/7 84 54 08</p>	<p>South Africa <input checked="" type="checkbox"/> SALES <input checked="" type="checkbox"/> Service</p> <p>TECTRA Automation (Pty) Ltd. 28 Banfield Road, Industria North RSA - Maraisburg 1700</p> <p>Telefon: +27 (0)11/673 20 80 Telefax: +27 (0)11/673 72 69</p>
<p>Taiwan <input checked="" type="checkbox"/> SALES <input type="checkbox"/> Service</p> <p>Rexroth Uchida Co., Ltd. No.1, Tsu Chiang Street Tu Cheng Ind. Estate Taipei Hsien, Taiwan, R.O.C.</p> <p>Telefon: +886 2/2 68 13 47 Telefax: +886 2/2 68 53 88</p>			

Kundenbetreuungsstellen außerhalb Europa - Service agencies outside Europe

**Außerhalb Europa / USA - outside Europe / USA**

USA <input checked="" type="checkbox"/> SALES <input checked="" type="checkbox"/> Service Mannesmann Rexroth Corporation REXROTH INDRAMAT Division 5150 Prairie Stone Parkway USA -Hoffman Estates, IL 60192-3707 Telefon: +1 847/6 45 36 00 Telefax: +1 847/6 45 62 01 E-MAIL: service@indramat.com	USA <input checked="" type="checkbox"/> SALES <input checked="" type="checkbox"/> Service Mannesmann Rexroth Corporation REXROTH INDRAMAT Division Central Region Technical Center USA - Auburn Hills, MI 48326 Telefon: +1 248/3 93 33 30 Telefax: +1 248/3 93 29 06	USA <input checked="" type="checkbox"/> SALES <input checked="" type="checkbox"/> Service Mannesmann Rexroth Corporation REXROTH INDRAMAT Division Southeastern Technical Center 3625 Swiftwater Park Drive USA - Suwanee Georgia 30174 Telefon: +1 770/9 32 32 00 +1 770/9 32 19 03	USA <input checked="" type="checkbox"/> SALES <input checked="" type="checkbox"/> Service Mannesmann Rexroth Corporation REXROTH INDRAMAT Division Northeastern Technical Center 99 Rainbow Road USA - East Granby, Connecticut 06026 Telefon: +1 860/8 44 83 77 +1 860/8 44 85 95
USA <input checked="" type="checkbox"/> SALES <input checked="" type="checkbox"/> Service Mannesmann Rexroth Corporation REXROTH INDRAMAT Division Charlotte Regional Sales Office 14001 South Lakes Drive USA - Charlotte, North Carolina 28273 Telefon: +1 704/5 83 97 62 +1 704/5 83 14 86			USA Service HOTLINE  <b>+1-800-860-1055</b>  - 7 days / 24hrs -

Kundenbetreuungsstellen außerhalb Europa / USA  
 Service agencies outside Europe / USA



284077

Printed in Germany